

Connect 12



User Guide



Table of Contents

Chapter 1: Introduction 3

Chapter 2: Getting to know your Prodigy 4

Box Contents 4

Prodigi Connect at a Glance 5

Setting up 12

Chapter 3: Using Prodigy 15

The Button Banner 15

Magnifying 16

Capturing 19

Full Page Capture 20

Multi-Capture 21

Reading 22

Handwriting Tool 27

Configuring and using the Rapid Toggle Feature 30

Activate the Blue Light Filter 31

Using the Carousel Menu 33

Downloading Books 33

Using the Applications Access 36

Using the Quick Access 37

Using the Calculator 38

Graphic Calculator Powered by Desmos 39

Viewing Saved Documents 40

The Gallery's Settings Menu 41

The Action Menu 42

Using the Distance Camera 48

Toggling between Distance Camera and Magnifier 50

Using Distance Camera and Magnifier simultaneously 51

Viewing Distance Camera Images 51

- Reading with the Distance Camera 52
- Removing Distance Camera from Stick 52
- Viewing text files in Prodigy 53
- Exam Mode 54
- OCR Language Selection 56
- Chapter 4: Choosing your Contrast 57
- Chapter 5: Standard Mode (tile) 59
- Chapter 6: Simple Mode 61
- Chapter 7: Changing your Settings 62
- Chapter 8: Bluetooth External Keyboard 70
 - The HumanWare Keyboard 70
 - Connecting a Bluetooth Keyboard 70
- Chapter 9: APH Code Jumper® 71
 - Connecting the Connect 12 to an APH Code Jumper® 71
- Chapter 10: Accessing Android 72
- Chapter 11: Help Menu 73
- Chapter 12: Recharging your Tablet 74
- Chapter 13: Recharging your Distance Camera 75
- Chapter 14: Software Update 76
 - Setting up your Wi-Fi 76
 - Automatic Update 76
 - Manual Update 77
 - Release Notes 77
- Chapter 15: Troubleshooting 78

CHAPTER 1: INTRODUCTION

Thank you for purchasing Prodigy™ Connect 12, the touch-controlled personal vision assistant system from HumanWare, global leader in assistive technologies for people who have low vision. Prodigy is a simple, intelligent, portable, and adaptable line of products aimed at restoring and maintaining independence for people living with vision loss.

Prodigy Connect is a complete magnification system that will allow you to magnify, read documents, and capture images anywhere you are.

Carefully read the operating and safety instructions described in this user guide prior to using your Prodigy Connect. If you have any questions about your system, please contact HumanWare Customer Service by consulting the contact information in the back of this user guide.

Copyright 2021 by Technologies HumanWare Inc., all rights reserved. No part of this publication may be reproduced or distributed in any form or by any means, or stored in a database or retrieval system, without the prior written permission of Technologies HumanWare Inc.

Note: Some features explained in this user guide may not be available in your language.

CHAPTER 2: GETTING TO KNOW YOUR PRODIGI

BOX CONTENTS

Tablet Box

- Prodigy™ Connect 12
- Power Supply Cable
- USB Cable
- Getting Started Guide
- Quick Start Guide
- User Guide
- Tablet Stylus Pen
- Warranty Sheet

Protective Carrying Case

- Folding Stand

Distance Viewing (Optional)

- Distance Camera
- AC adapter
- USB cable
- Wrist strap
- Camera Stick
- Camera Quick start Guide
- Camera User Manual
- Warranty card
- Service card

PRODIGI CONNECT AT A GLANCE

Front Face

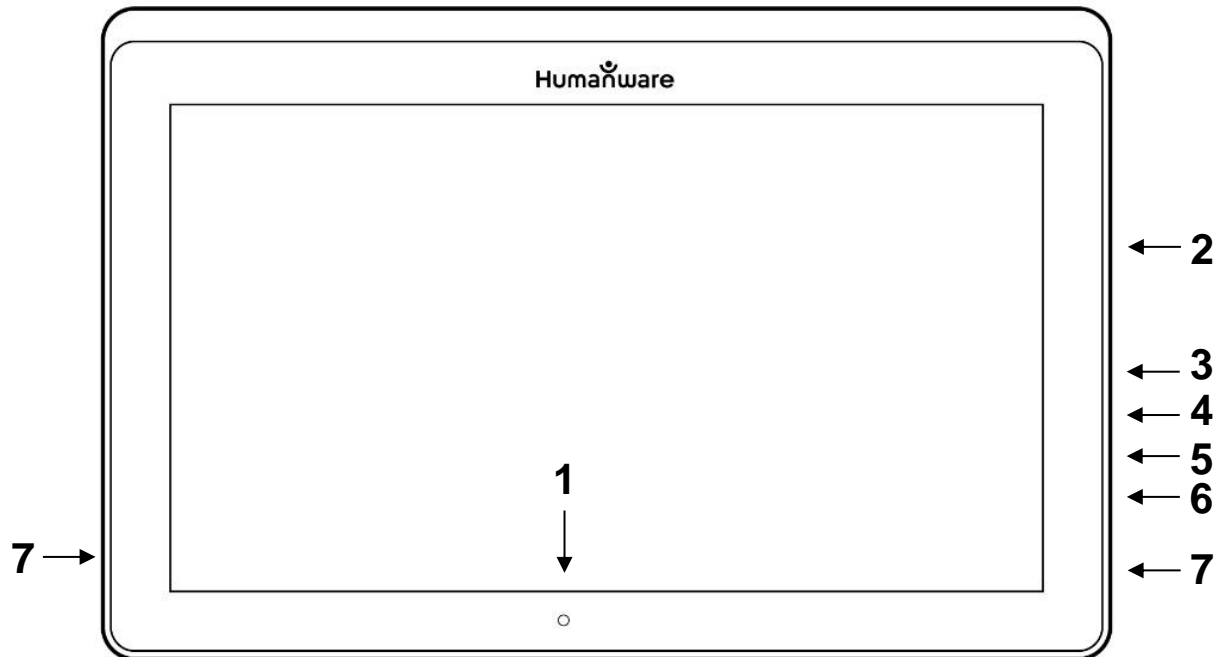

1. Front-facing camera
2. Micro-SD slot
3. USB-C port
4. Recharge port
5. High-Resolution video micro-port
6. Headphone jack
7. Speakers

Bottom Edge



1. Volume Down-Up
2. Power Button

Back Side

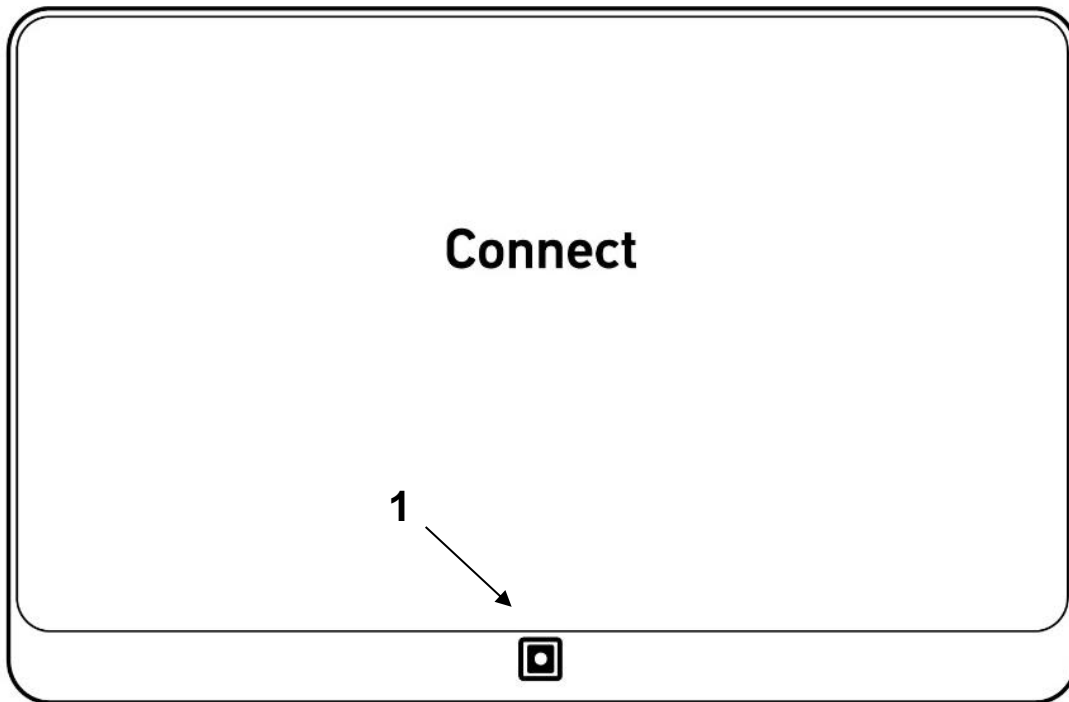

1. Camera

Button Banner

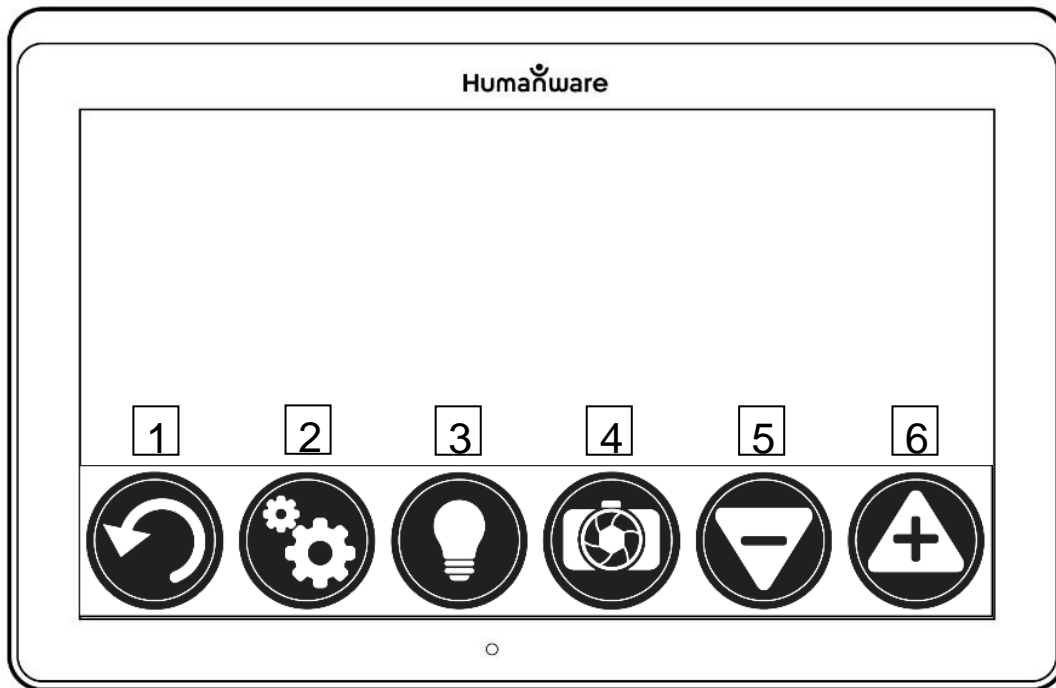

1. Back button
2. Settings button
3. Light Button
4. Capture/Read Button
5. Zoom Out Button
6. Zoom In Button

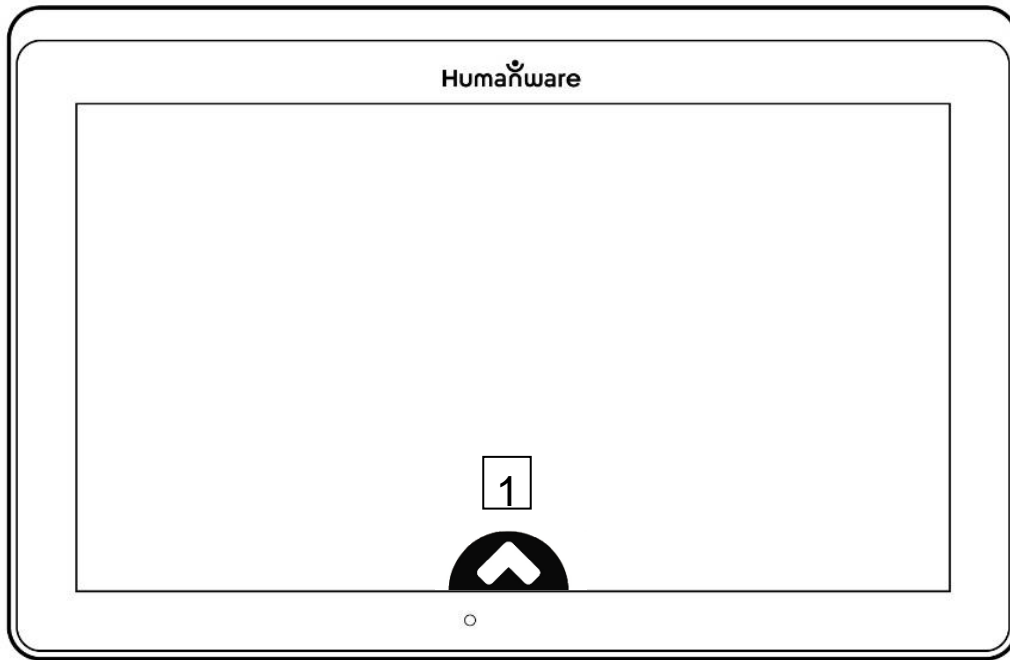

1. Open Banner Button

Folding stand

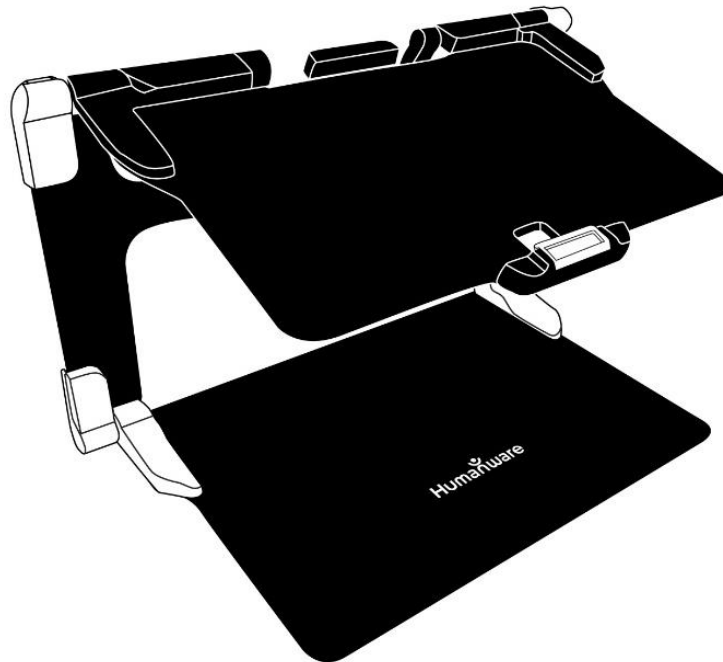

Distance camera

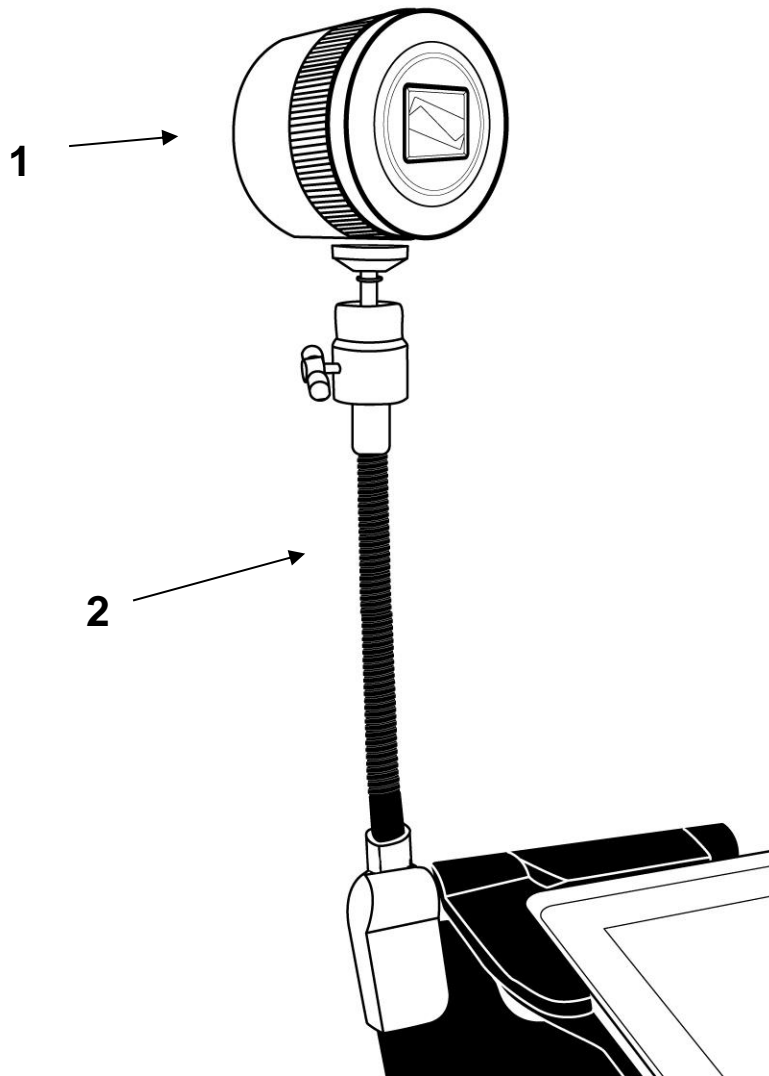

1. Distance camera
2. Distance camera stick

Front view

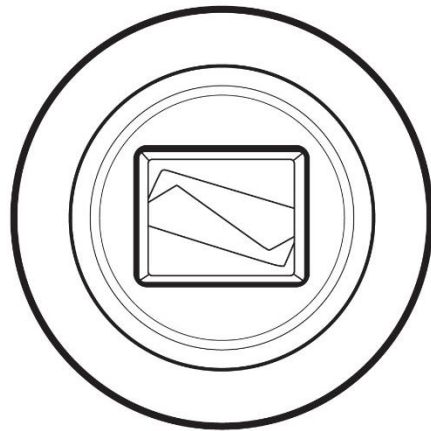

Top view

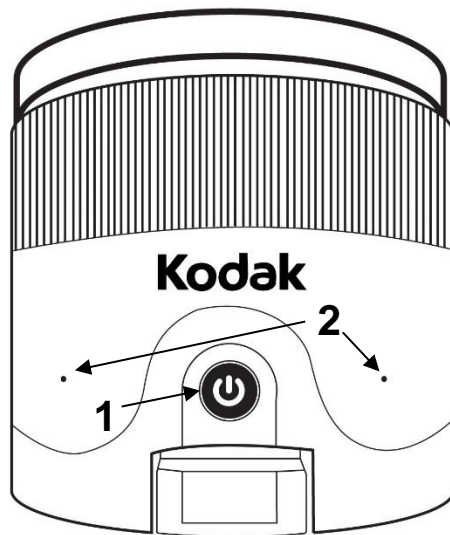

- 1. Power button
- 2. Microphones

Left view

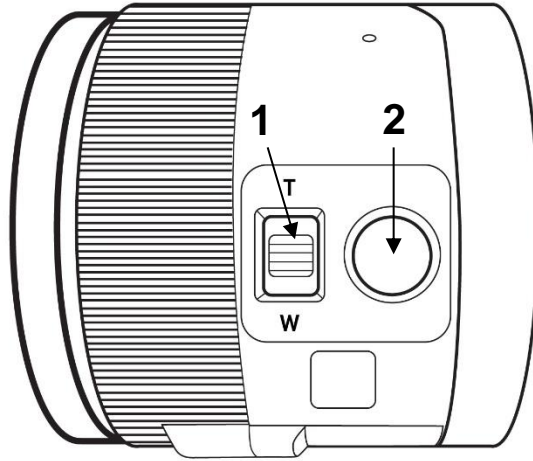

1. Zoom lever
2. Shutter button

IMPORTANT: It is essential to keep the Quick Start guide provided with your distance camera as it contains your camera's pairing information.

SETTING UP

1. On a flat and stable surface, hold your stand upright, making sure the panel with the word “Connect” is facing towards the back. Hold the handle with one hand, and unfold the lower panel with your other hand until it is flat on the table.

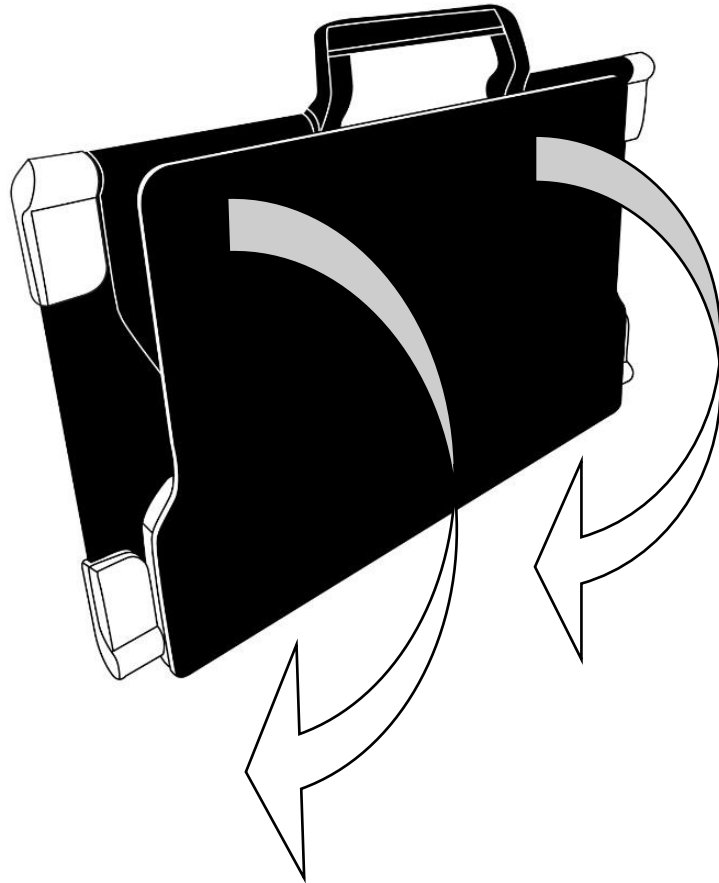

2. Unfold the top panel until it is roughly parallel with the lower panel.

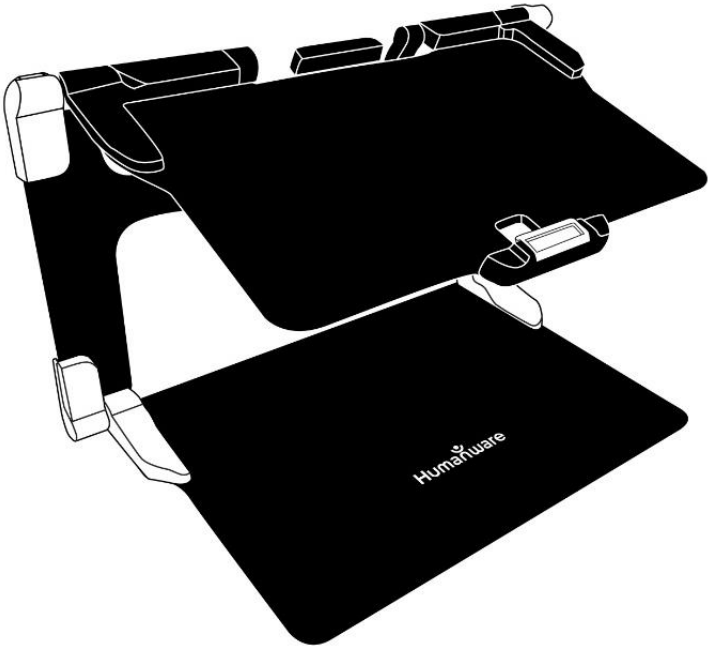
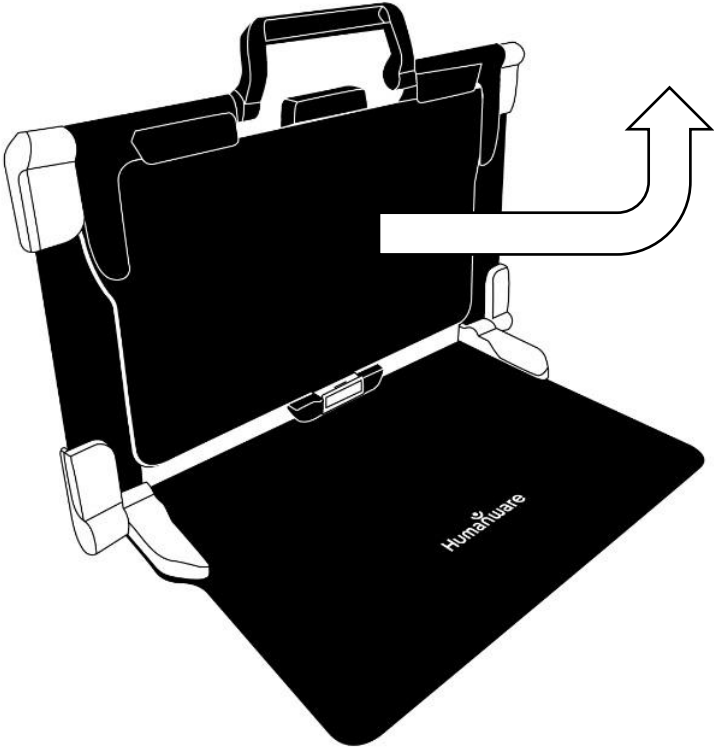

3. Hold your Prodigy Connect with the screen side facing you, making sure the HumanWare logo is at the top. Carefully insert the top of your tablet into the slot and slide it forward until you reach the back end of the slot. Push the bottom part of the tablet down; you will hear a click indicating that your tablet is fastened.



4. Connect the power supply cable to the recharge port and plug it to an outlet. The recharge port is located on the right side of the tablet. Allow the tablet to recharge until the battery is full.

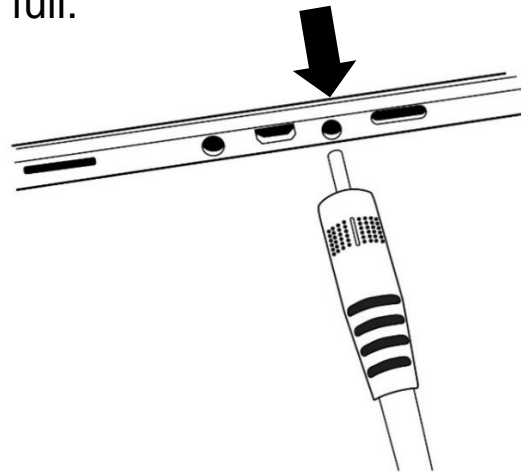

IMPORTANT: Use caution while inserting the cable into the recharge port.

5. Press and hold the power button to power on your tablet. The HumanWare and Android logos will appear on screen. Your tablet will take about 30 seconds to initialize.

CHAPTER 3: USING PRODIGI

THE BUTTON BANNER

Most of Prodigy Connect's actions are performed through the Virtual Button banner located at the bottom of your screen.

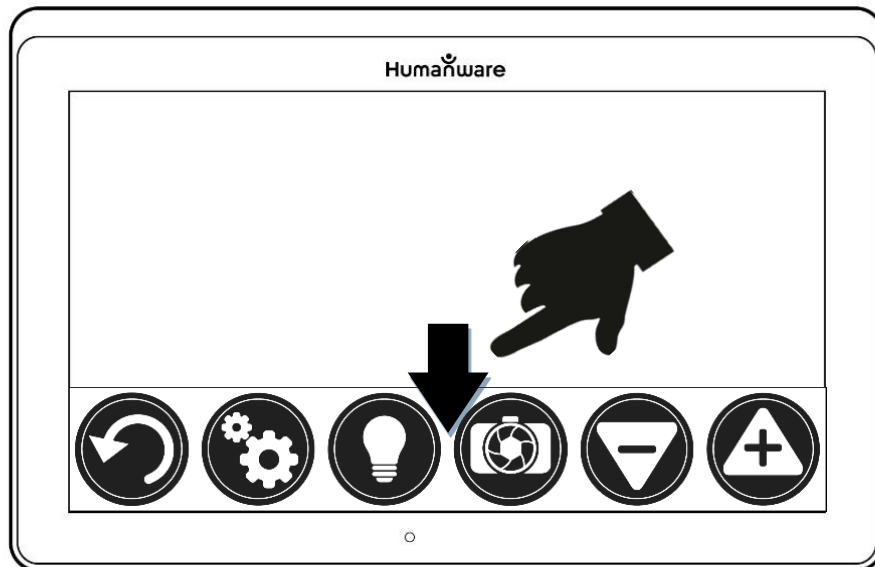

If you wish to hide this banner to better see your screen, do a **downward swipe** on the button banner (move your hand downwards while touching the screen with a finger). The banner will be replaced by the Open Banner button at the bottom of your screen.

Tap this button or **swipe upward** or tap on the button to display the Button Banner.

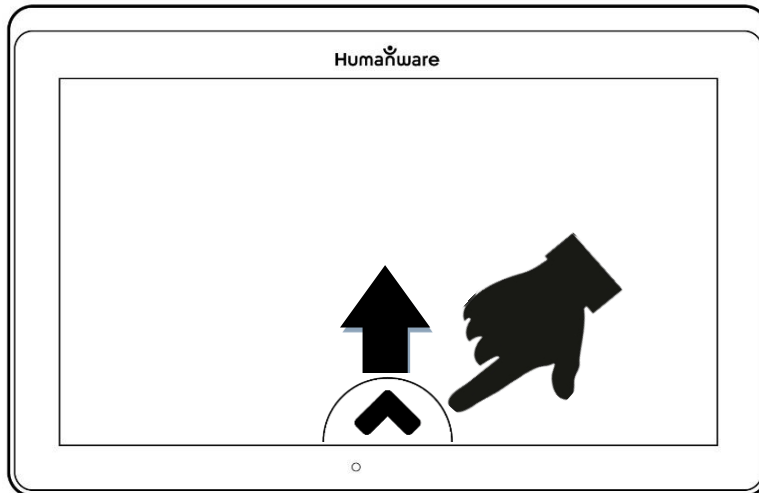

MAGNIFYING

- Power on the tablet.
- If you use the “Rear” camera, align the tablet above the document or object you wish to view.
- If you use the “Front” camera, place yourself in front of the tablet for a mirror/self-view.
- Open the magnifier application from the carousel, tile or simple menu by tapping on its icon:



- Choose the rear camera if you wish to magnify an object or a document. Choose the front camera if you wish to view yourself. You can switch the cameras by tapping on

the Settings icon, then toggle between the cameras by tapping on Front/Rear.



You may also quickly access the front/rear camera option by performing a long press (3 seconds) on the camera icon.



When using the front facing camera, please take note the OCR (Optical Character Recognition) feature is automatically disabled.

- Move the object or document under your tablet to find the information you are looking for.
- Tap the **Zoom In-Out** buttons to adjust the zoom level. To increase character size, tap the **Zoom In** button (+). To decrease character size, tap the **Zoom Out** button (-). You can also tap and hold the Zoom In-Out buttons to progressively adjust the zoom level, and release once you reach your desired zoom level.



- In addition to the Zoom In-Out buttons, you can use the **pinch and zoom** gesture to adjust the zoom level.

Decrease the distance between 2 fingers to zoom out, and increase the distance to zoom in:



- To toggle between **color**, **positive**, and **negative** contrasts, simply swipe vertically on the right side of the tablet's screen (see Chapter 4: Choosing your contrast for more details).

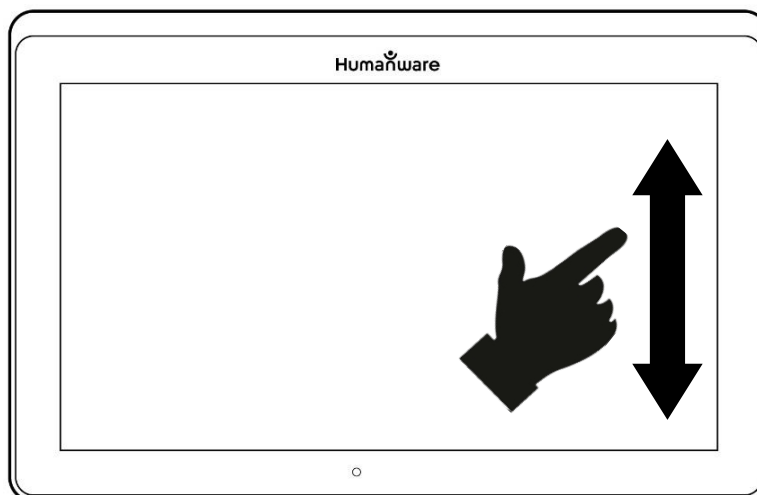

Note: Prodigy Connect allows you to decide whether to lock or unlock the camera's autofocus. This is useful when the right focus is displayed for the document and you want to lock its position, or when you are performing a manual task like writing on a piece of paper, and want to prevent your tablet from

refocusing on your hand or pencil, for example. To lock autofocus, simply perform a **double tap** gesture (tap twice quickly) anywhere on your screen. Double tap again anywhere on the screen to unlock autofocus. The following icon will appear on the right side of your screen when autofocus is turned off:



CAPTURING

- Using the folding stand, position the tablet above the document or object you wish to capture.

Note: The tablet does not need to be perfectly aligned above your document; by default, Prodigy Connect will automatically correct the angle of your tablet. On screen, two triangular shapes on each side of your document will indicate angle correction. You can change this by accessing the Settings. Tap the Settings button, swipe up to select Angle Correction and select Enabled or Disabled. Tap Back to exit.

- Tap the Capture button to capture your document or tap and hold your finger on the screen for 2 seconds.



- You will hear a picture sound, followed by a clicking sound, indicating that the document has been captured.

- Once you make a capture, the Light button will be replaced by the Save button. This button allows saving of capture in Gallery.

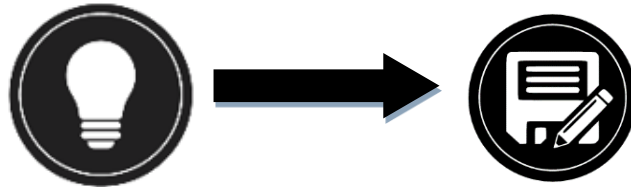

- Tap the Save button to save your document in the Gallery for future use.
- Tap the Back button if you want to return to Magnifier Live mode.

FULL PAGE CAPTURE

To capture a full page:

- Instead of laying your sheet vertically, place your sheet sideways (landscape position) so that the top of your text is located under the left edge of your Prodigy Connect, and the bottom of your text is located under the right edge of your tablet.
- From Magnifier mode, tap the Zoom Out button once. This will activate full page view, turn on LED and reduce the button banner.
- Align your page visually under the stand so that all of the text is displayed on-screen.
- Tap the Capture button or press and hold your finger down on the screen to capture.

Tip: To capture more text, you can raise the tablet further from the document, allowing more view angle.

To return to Live mode and capture smaller objects or documents, simply tap on the Button Banner button to open it and press the Zoom In button once.

MULTI-CAPTURE

- To capture a multipage document, toggle to **Multi-Capture mode** by swiping vertically on the left side of the tablet's screen:

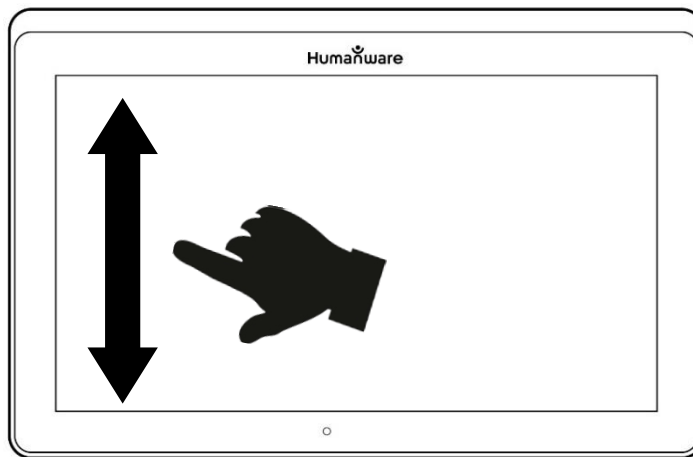

Note: You can also toggle to Multi-Capture mode from the Settings. Tap the Settings button, swipe up to select Mode, and tap to set it to Multi-Capture. Tap Back to exit the Settings.

- You can now capture a multipage document. Align the tablet above the first page of the document you wish to capture and tap the Capture button or press and hold your finger down on the screen. Proceed in the same way for each page you wish to capture. Your multipage document will be saved in the Gallery for future use.
- Tap on the Gallery icon.



- Tap on the first page of your document to open it. Tap the Read button to start reading.
- When you are done reading, tap the Back button to return to your document. Tap Back again to return to Magnifier mode.



READING

Once you make a capture, the Capture button will change from a camera image to a play symbol. This is now the Read button.

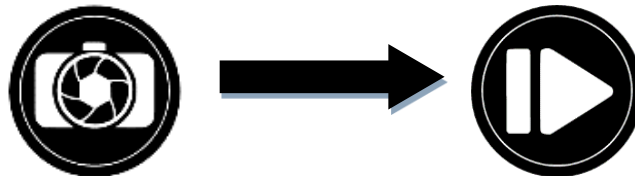

- Tap Read or long press anywhere on the screen for 2 seconds to scroll and read aloud the text according to your reading preferences. You can also do a long press on a specific word in the document to start reading on that word.



Note: When you press read, the Button Banner will collapse to provide a better view of your image. It can be re-opened by pressing the Open Banner Button or by doing an upward swipe on the lower section of the screen.

- To adjust the volume, use the Volume Down-Up buttons.
- To pause, tap Read again or long press anywhere on the screen.
- While paused, tap Back to exit reading view, and Back again to return to the camera view.



- To resume, tap Read again or long press.

When in magnifier mode, reading mode allows you to zoom in and out of your captured document.

To zoom in a captured document:

- Use the **Zoom In-Out** buttons to adjust the zoom level. To increase character size, tap the **Zoom In** button (+). To decrease character size, tap the **Zoom Out** button (-). You can also tap and hold the Zoom In-Out buttons to progressively adjust the zoom level, and release once you reach your desired zoom level.

- In addition to the Zoom In-Out buttons, you can use the pinch and zoom gesture to adjust the zoom level.
- To instantly zoom to an area of interest, perform a single tap on the area you wish to view and the image will zoom at that location at your preferred zoom level.
- If you are in a zoomed level over 1X, you can move around your zoomed document by doing a **Pan Gesture** (slowly move your finger on the screen without lifting it).

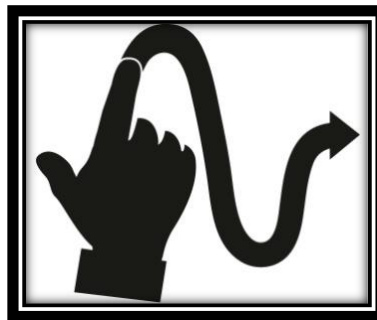

- Pan to reach other parts of the enlarged image.
- To toggle between the different contrasts, swipe on the right edge of the touchscreen or access the Settings (see Chapter 4: Choosing your contrast for more details).

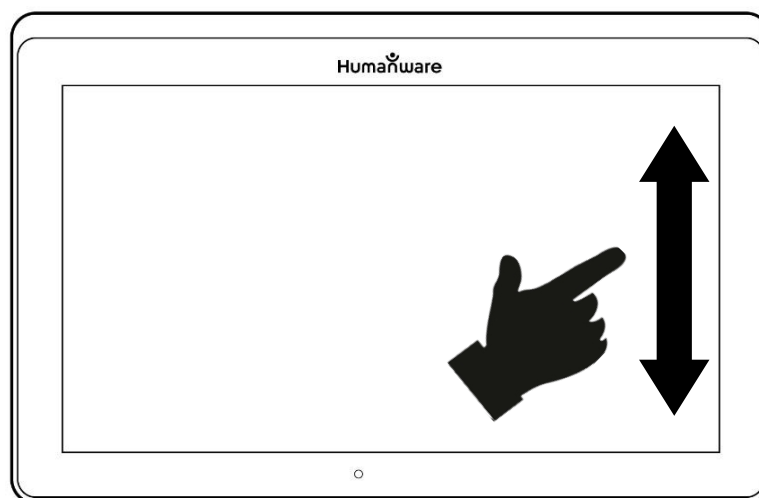

Note: Text can be presented in 3 different formats (Reading Modes): it can be changed in the settings to a single line in the Line mode, a column in the Column mode (default), or you can read text without losing its configuration in the Page mode. Two “greater than” signs will identify the end of a paragraph in the Line and Column modes (>>).

Prodigy Connect will beep and announce “End of document” when you reach the end of your document; tap Read to start reading from the beginning again.

- To set a different Reading Mode, tap the Settings button and swipe up to select Reading Mode.



- Tap Reading Mode to toggle the value. Tap Back to exit the Settings.
- You can temporarily increase the speech rate while reading by swiping to the left (sliding and releasing your finger to the left) on the touchscreen, and decrease the speech rate by swiping to the right. Note that changing the speech rate will change the reading speed (text scrolling speed) accordingly.

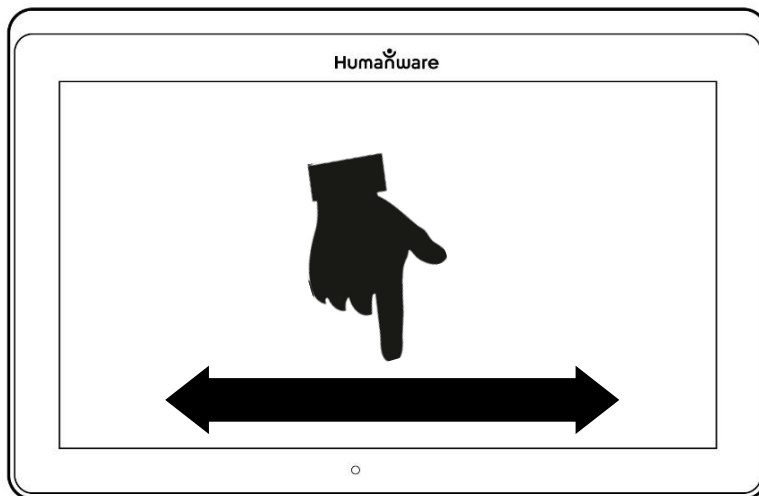

Note: You can also increase or decrease the speech rate permanently from the Settings. Tap the Settings button, select Speech Rate, and select a value. Tap Back twice to exit Settings.

Note: You will be able to change the reading speed (text scrolling speed) by swiping left or right, or from the Settings even when speech is deactivated.

- To toggle between Speech On and Off, simply double tap on the screen while reading. Alternatively, tap the Settings button, select Speech, and select Documents only or Off.
- Prodigy Connect has 4 different voices that can be used to read aloud text documents. To select a different voice, tap the Settings button, select Voice, and tap to toggle between the 4 reading voices.

- Tap Back to return to your document. Make sure that the language of the selected voice is the same as in the document you want to read.
- Tap Back to stop reading and return to camera view.

HANDWRITING TOOL

Connect features a handwriting tool useful for highlighting, drawing on or writing text on your captured images.

To open the Handwriting Tool:

- Open a saved image from the Gallery or save a captured image in the Magnifier.
- Tap the Pen and Ruler icon from the button banner. This is the Handwriting Tool button.

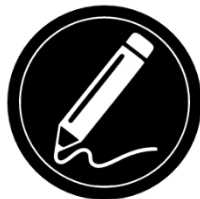

Once in the Handwriting Tool, you will notice 4 new buttons on the button banner.

The Tool Selection button allows you to select between the Pen, the Highlighter or the Text Tool. The icon displayed will change depending which tool is currently selected.

The Pen, Highlighter and Text tool icons are shown below.



The Eraser Tool is used to erase pen/highlighter strokes and text.

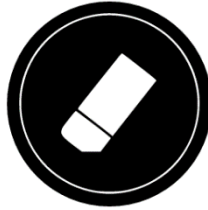

The Color Selection button opens the color menu. Tap it to choose the color of your selected tool.



The Size Selection button opens the size menu. Tap it to choose the size of your text or the pen/highlighter strokes of your selected tool.



To use the pen or highlighter:

- Select either the pen or highlighter by tapping the Tool Selection button on the Button banner (second button). Drag your finger on the screen to draw strokes with the pen or highlighter.

To erase text or pen/highlighter strokes:

- Select the Eraser Tool by tapping the Eraser Tool button (third button).

- Drag your finger over what you wish to erase.
- When you are done, deselect the Eraser Tool by tapping the Eraser Tool button again.

Note: The Eraser Tool will only erase strokes of the selected tool type.

To write text:

- Select the Text Tool by tapping the Tool Selection button on the button banner (second button).
- Press and hold your finger on the screen where you want to write your text.
- A virtual keyboard will appear on your screen; use it to type in your text. You can also use a physical Bluetooth keyboard if you have one paired with your device.
- When you are done typing, press the Paper Plane button on the top right corner of your screen to validate your text. Alternatively, you can press **Ctrl + Enter** to validate your text if you are using a Bluetooth keyboard.

To move your text:

- Select the Text Tool by tapping the Tool Selection button on the button banner (second button).
- Tap once on your text to select it. You will see a red box appear around your text meaning it is now selected.
- Drag your text to its new position.
- Tap anywhere on the screen to deselect your text.

To resize your text:

- Select the Text Tool by tapping the Tool Selection button on the button banner (second button).
- Tap once on your text to select it. You will see a red rectangle around your text which means it is now selected.
- Change the text size by making a pinch gesture: decrease the distance between 2 fingers to reduce text size, and increase the distance to enlarge your text.
- Tap anywhere on the screen to deselect your text.

To Pan in an image that is being edited:

- Place two finger on the image.
- Drag your fingers up, down, right or left.
- When finish lift your fingers of the image.

Note that if the distance between the fingers vary while panning, the image will zoom in or out.

CONFIGURING AND USING THE RAPID TOGGLE FEATURE

Rapid Toggle allows you to quickly access your favorite applications by swiping across the screen.

To use the Rapid Toggle feature:

- Go to Settings and tap on the Applications item.
- Select the Rapid Toggle application.

- To enable the Rapid Toggle feature, you must select at least one application. You may use Search to manually type the application you wish to add, or Select Application to select as many apps you wish from a list.
- Rapid Toggle is possible by swiping 2 fingers at the middle of the screen, starting on the left and off screen towards the right of the screen. Prodigy will detect your swipe and toggle to the next app you have selected to be part of your list.

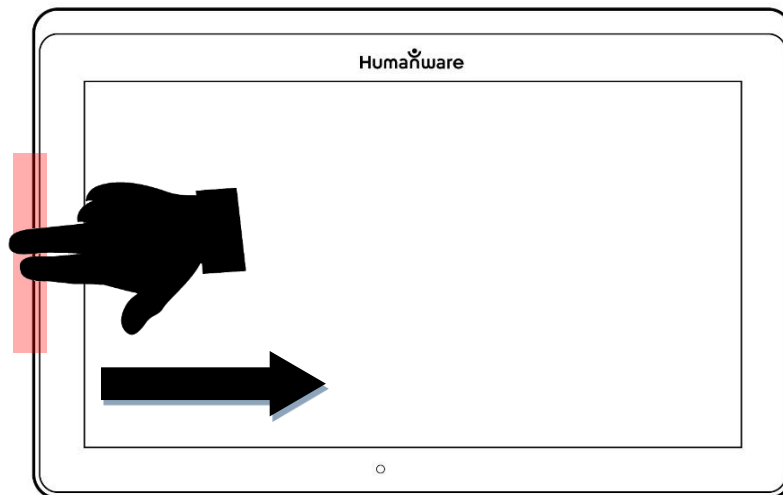

- You must swipe every time you want to toggle. Rapid Toggle will toggle to the next app using the same order in which you selected them.
- The Rapid Toggle can be used from any application.

ACTIVATE THE BLUE LIGHT FILTER

Prodigi is equipped with a blue light filter that allows you to reduce the amount of blue light displayed on the screen. Blue light is known to reduce the production of melatonin,

which is a sleep-inducing hormone, so filtering it is a useful way to prevent insomnia.

To activate/deactivate the Blue Light Filter on the Connect 12:

- From the Carousel Menu, select the Settings icon:



- In the Settings menu, choose the option 'User interface'.
- Choose the option 'Blue Light Filter'.
- Four levels of filter will be available: low, medium, high, and max. Choose the item of your choice by tapping on it.
- The screen color is now changed according to your choice.
- When the Blue Light Filter is set to on, you can deactivate it by going back in the Blue Light Filter menu and selecting the option 'Off'.

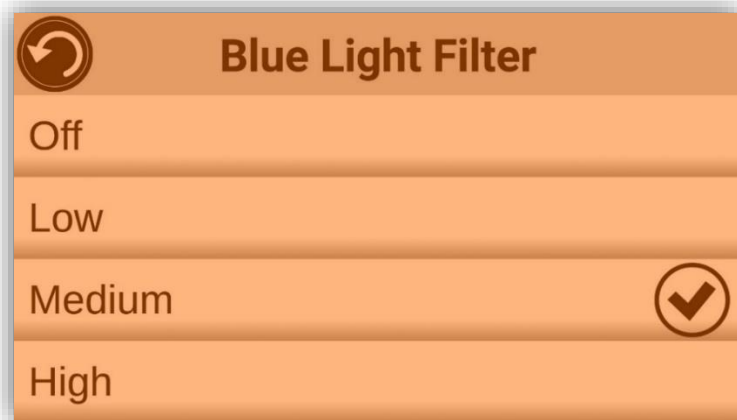

USING THE CAROUSEL MENU

Prodigi Connect has 9 main applications – Apps access, Quick access, Calculator, Books, Distance camera (only available if distance camera option is purchased), Magnifier, Gallery, Settings, and Help. They are presented one by one in the carousel menu:



To access the carousel menu from the Magnifier:

- Tap Back to close the Magnifier and access the carousel menu.
- Prodigi will announce “Main Carousel” followed by the currently selected application.
- The currently selected application is positioned in the center of the screen.
- Swipe left or right in the carousel menu to select an application.
- To launch a selected application, simply tap.
- To cancel and return to the carousel menu, tap Back.

Note: You can access the Carousel menu from anywhere in the system by double tapping with two fingers anywhere on the screen.

DOWNLOADING BOOKS

Prodigi Connect’s Books application allows you to download eBooks, magazines and other periodicals provided through various international libraries.

To download reading material:

- Select and tap on the Books icon in the Carousel menu:



- When opening Books, you must select one of the Books or Subscriptions providers from a list. To do so, select Manage libraries, then select Book providers or Magazine providers.
- Tap any library and authenticate with the username and password you have been provided with by that organization. First, enter your username and tap the blue button on the right side of the keyboard. Then, enter your password and tap the blue button again. Your login information will be saved.

Note: Your password will be hidden by default. Tap the Eye icon on the right of the password field to show your password in clear text. Tap again to hide your password.

Once you have successfully authenticated, tap the Back button twice until you return to the main Books menu. Each library for which you have established a successful login will now appear on this list.

- Each library has different search fields. Some may offer you to look up either by: Title, New releases, Author, Keyword, Category, Content, ISBN, etc.

- To download a book you would like to read, tap the Download button while viewing book details. The book will be added in My Books submenu.
- To read a book you downloaded, select My Books submenu. Select the book from your list and tap to open it.
- To download a magazine or newspaper, you first need to subscribe to the periodical by going into the Periodicals submenu, select a category, tap on the periodical you would like to subscribe, a check mark will appear on the right and a popup windows will inform you that you have added the periodical to your library.
- Tap on the back button twice to go back to the books main menu.
- To read a magazine or newspaper you downloaded select My Subscriptions, select the magazine or newspaper you want, tap on the issue that has a big black arrow on the right of its issues date. Once the download completed, tap on the issue to start reading it.
- Press Read to start reading it as you would for any other document.
- Press Read again to pause. You will then be able to swipe left or right to navigate between the book's pages.
- You can also navigate by chapter in your downloaded book using the Table of Contents button on the button banner:



- You will see a list of the downloaded book's chapters, swipe up or down in the list, select a chapter, and press Read to start reading from that point.
- Press Back to exit and return to your list of downloaded books. Press Back again to return to Books' menu.

USING THE APPLICATIONS ACCESS

Prodigi Connect allows you to access all the applications that you would normally find on an Android smartphone or tablet.

To access the applications:

- Select and tap on the Applications icon in the carousel or the tile menu:



- A new menu appears, offering two different options to access an application: Search and Show All.
 - The Search option allows you access the application you are looking for by typing its name.
 - The Show All option displays a list of all the installed apps on your Prodigy.
- Once you find the application you were looking for, you can open it by simply tapping on its icon.

- If an application you are looking for does not figure on the list, you can download it from Play Store. Once the download and installation are completed, the application will be added to the list.
- Tap the Back button to return to the Carousel or Tile menu.

USING THE QUICK ACCESS

The Quick access item allows you to reach more easily the applications you use the most on your Connect 12, with the ability to add as many of your favorite applications to your Prodigy Carousel.

To add an application to the Quick access menu:

- Select and tap on the Quick access icon in the Carousel or the Tile menu:



- Tap on the Add icon if you wish to add an application to the Quick access menu:



- A new menu appears, offering two different options to access the application you wish to add to the Quick access: Search and Show All.

- The Search option allows you access the application you are looking for by typing its name.
- The Show All option displays a list of all the installed apps on your Prodigy.
- Once you find the application you were looking for, you can add it to the Quick access menu by simply tapping on its icon.
- If you wish to remove an application from the Quick access menu, simply press and hold on the application icon, then tap on delete.
- If you wish to move the application at a different location in the list, simply press and hold the application and select switch and select the application you to switch it with.

USING THE CALCULATOR

Prodigy Connect allows you to perform calculations with the Calculator application.

To use the Calculator:

- Select and tap on the Calculator icon in the Carousel or the Tile menu:



- Tap on the numbers and signs. Your calculation will appear on the top section of the screen. Tap DEL to correct it if necessary, or equal to see the answer.

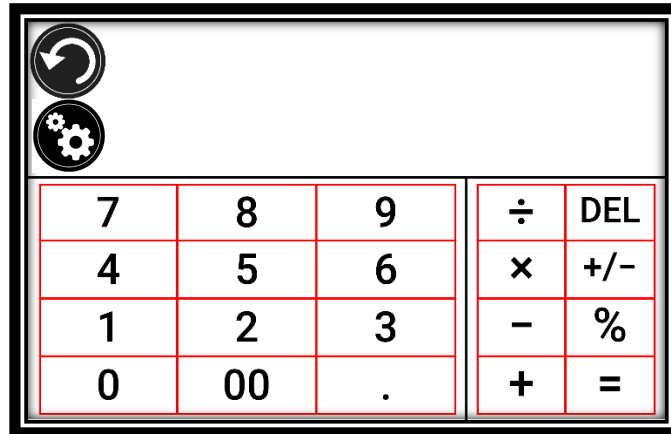

- Once you have your answer, you can tap CLR to clear the top section.
- By default, the Calculator is set to standard mode. To use mathematical functions such as sin, cos, tan, etc., you will need to toggle to scientific mode. To do so, press the Settings button and tap to set the Calculator mode setting to scientific. Press Back to return to Calculator. You will then be able to tap the two arrows on the lower center of the screen to access scientific mathematical functions.
- Tap the Back button to return to the carousel menu.

GRAPHIC CALCULATOR POWERED BY DESMOS

The integration of Desmos' graphic calculator to the Connect 12 means users can draw their own graphics directly on their tablet by simply entering their equation.

To switch to the graphic calculator:

- Press the Settings button in the Calculator.
- Press Mode
- Select "Graphing"

- Press back twice to return to the Calculator.

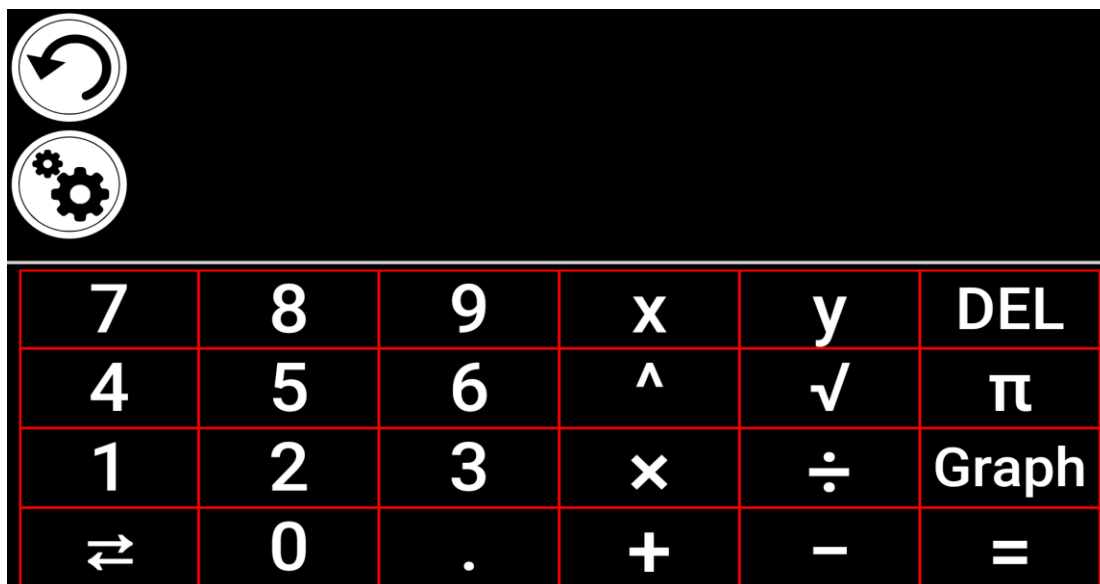

To draw a graphic, simply write a valid equation then press “Graph”. E.g. $3x+2=y$, $y=4$, $0.5+x^2=y$, etc.

Press the Plus and Minus buttons to zoom in and out of the graphic. Swipe your finger on the screen to pan the graphic.

Advanced mathematical operators are available by pressing the button with two opposing arrows in the bottom left corner of the calculator’s keypad.

When a Graph is displayed on the screen, it can be captured and saved in the Gallery under the Screenshots folder.

VIEWING SAVED DOCUMENTS

The Gallery contains all the documents you have saved.

- Select and tap on the Gallery icon in the carousel menu:



- Swipe left or right in the Gallery to flip through your saved documents. Note that all the screenshots taken on the device are saved in a Screenshots folder.
- The currently selected document is in the center of the screen. Prodigy Connect will announce and indicate the first word contained in the currently selected document. If the document contains no words, Prodigy Connect will tag it as an image. A notebook icon will indicate a multipage document:

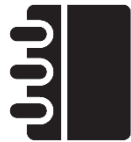

- To open a selected document, simply tap.
- Tap somewhere on the document to see that section at your preferred zoom level.
- You can toggle between color, positive, negative, and Diamond Edge™ (if the image contains text) contrasts, and adjust the brightness in the same way as with the Magnifier (see section Magnifying for more information).
- Once you are in a zoomed level over 1X, you can move around your zoomed document by doing a Pan Gesture.
- Pan to reach other parts of the enlarged image.
- Tap or tap Back to return to the full image view.
- When in full image view, tap Back to close a document and return to the Gallery.

THE GALLERY'S SETTINGS MENU

The Gallery's Settings Menu allows you to:

- Create categories and subcategories (folders)
- Create a new page
- Create a new document
- Create a new note
- Append pages in a multipage document
- Reach a specific page number in a multipage document

To access the Gallery settings, simply tap the Gears icon in the top right corner of your screen while in the Gallery.

THE ACTION MENU

The Gallery features an “Action Menu” that includes many useful functions for your saved documents.

In the Action menu, you can:

- Share an image through other Android apps
- Renumber the first page of a multi-capture document
- Rename a document or category
- Delete a document, category, or the content of a category
- Move a document to a category
- Export a document to a JPG, text or PDF file in the Android file system or an external drive.
- Move an image captured with the distance camera to the Gallery for Diamond Edge processing
- Delete, replace or insert pages in a multipage document
- Run the OCR on a PDF document (useful when parts of a PDF document are not properly rendered, usually within tables).

To access the Action menu, simply long press on a captured image, a document or category icon in the Gallery. You will be directed to a menu listing available actions for your selected file.

To share an image through other Android apps

- Long press on the image you want to share
- Tap Share
- Select the format in which you want to share the image (PDF or JPG)
- Select the app through which you wish to share your image (e.g. Gmail, Maps, Google Drive, etc.). Please note that the apps listed in the share menu may not be accessible.

To delete a document, a category, or the content of a category

- Long press on the document or category you want to delete.
- Tap Delete, Delete category or Delete category content.
- Tap Yes to confirm deletion.

To rename a document or category

- Long press on the document or category you wish to rename.
- Tap Rename or Rename category.
- Type in the new name of your document or category.
- Tap DONE (Enter key on keyboard).

To move a document to a category

- Long press on the document you want to move.
- Tap Move.
- Tap the category where you wish to move your image.

To import a JPG, text or PDF file from an external drive to the Connect12

- To make your USB key detected by the system, you need to modify the USB settings in the Android system:
 - Press and hold four or five fingers on your screen. A page displaying all the Android apps will appear.
 - From the apps page, select Settings.
 - In the Device list of the Settings menu, select USB.
 - At the top of the screen a message will display: “USB is connected to the computer”. A toggle at the right of the screen allows you to change it to “USB is not connected to the computer”.
 - Tap on the circle at the bottom of the tablet to go back to Prodigy.
- Insert your USB key in the USB-C port at the right of the tablet. If your USB key is not compatible with a USB-C port, use the USB to USB-C connector.
- Select and tap on the Gallery icon in the Carousel menu:



- Tap on the Settings icon at the top-right of the screen, then select Import:



- Two storage options will be displayed: the Internal storage and Store N Go, corresponding to your USB key. Tap on the Store N Go option.
- Your USB key will appear. Press on its name, then press on Select to open it. All the folders and files stored on your USB key are now accessible.
- Tap on the files of your choice to import them to your Gallery. They will be automatically downloaded on your Connect 12.

To export a document to a JPG, text or PDF file in the Android file system or an external drive

- In the Gallery, press and hold on the document you wish to export.
- Tap Export.
- Select in which file type you wish to export your document. It is possible to modify some JPG and PDF settings by pressing and holding either the PDF or JPG option (advanced users only).
- Select the Internal storage to export to a specific folder on the device. You can also select the USB device option if a USB key is placed in the USB port of the tablet to export it to the USB thumb drive.

To move an image captured with the distance camera to the Gallery

- In the Distance category, hold your finger on the image you wish to move.
- Tap Move to Gallery.
- The image will be treated to find text and display Diamond Edge if text was found. The file will be renamed to first found word in document, if text is found.
- The file can be then moved into a Category if required.

To delete, replace, insert, or append a page in a multipage document

- Open the multipage document you wish to modify.
- To delete a page, long press on the page you wish to delete and tap Yes to confirm deletion.
- To replace a page, long press on the page you wish to replace. Tap replace, tap yes and capture a new page.
- To insert a page, long press on the page where you want to insert a new page. Tap insert and capture a new page.
- To append one or several pages, long press on any page in a multipage document and tap append. Capture your document. The page(s) will be added at the end of the multipage document.

To add a function graph in a document

While editing a document, you have the option to add a function graph.

- Select and tap on the Gallery icon in the carousel menu:



- Open a document.



- Perform a long press on an item inside the document.
- A settings submenu will appear. Select the option 'insert'.
- The insert options will appear on the screen. Select the option 'New Function Graph'.
- Prodigy will open the calculator app in the graph mode. Enter a formula and selects the 'graph' button.
- Prodigy will open the graph view with the user function plotted. Tap on the 'save' button.



- Prodigy will return to the document with the graph image inserted in the select position.

Alternatively, if you wish to append a function at the end of a document:

- Select and tap on the Gallery icon in the carousel menu:



- Open a document.



- Tap on the 'more options' button on the top right corner of the screen. A menu will appear.



- Selects the option 'Append'. The append menu will appear on the screen.
- Select the option 'New Function Graph'.
- Prodigy will open the calculator app in the graph mode. Enter a formula and selects the 'graph' button.
- Prodigy will open the graph view with the user function plotted. Tap on the 'save' button.



- The graph will appear at the end of the document.

USING THE DISTANCE CAMERA

Prodigy Connect features a distance camera that can be extremely useful when you need a better view of something at a distance, such as a presentation or the teacher's slides

during a lecture. Your distance camera connects wirelessly, has a battery duration of 4 hours, and can be set up to 30 feet (10 meters) from Prodigy Connect. The camera comes already paired with your tablet out of the box. **Note:** The distance camera is only available if you bought the Distance Viewing Option with your Prodigy Connect.

- To use the distance camera, first align your camera with the object you wish to view.
- Turn camera On.

Insert your camera into the camera stick slots, located on either side of the folding stand's frame.

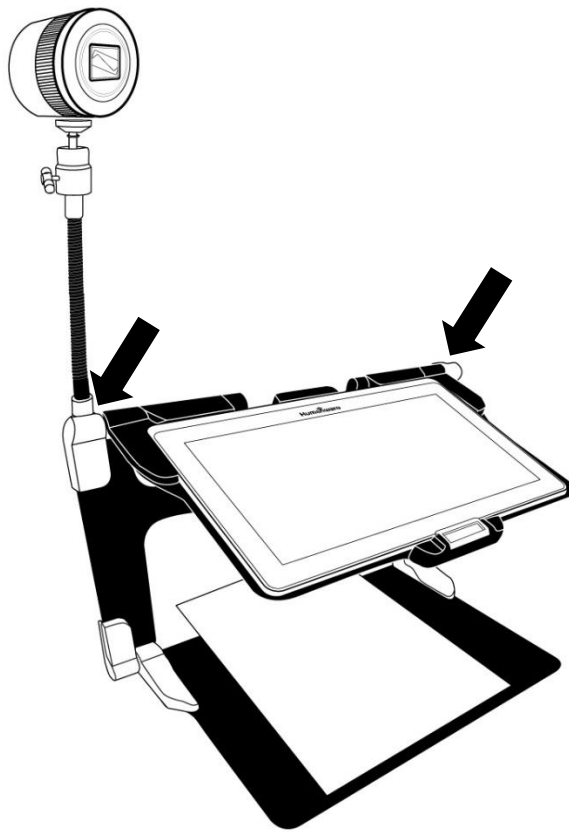

- Enter the Carousel menu by tapping the Back button in the magnifier mode.
- Select the Distance Camera icon, then tap.



- You are now in your camera's live view. To take a picture, Tap the Capture button. Alternatively, you can take a picture by holding down the Shutter button located next to the Zoom lever on the left side of your camera.
- You should hear a camera shutter sound and briefly see the picture you just took, then return to the camera's live view.
- You can zoom in or out by tapping or tapping and holding the Zoom In and Out buttons. Alternatively, you can use the Zoom lever located next to the capture button on the left side of your camera.
- Tap Back to return to the carousel menu.

TOGGLING BETWEEN DISTANCE CAMERA AND MAGNIFIER

During a lecture, you may want to switch quickly between the distance camera and the magnifier to note down what the teacher is writing on the board.

To switch between the distance camera and the magnifier view seamlessly, simply swipe your finger on the screen from left to right. Swipe again from left to right to return to your previous view.

USING DISTANCE CAMERA AND MAGNIFIER SIMULTANEOUSLY

It is possible to use the distance camera and magnifier simultaneously. To do so, simply touch the arrow on the left side of the screen and your screen will split into two with the distance camera in the top section and the magnifier view in the bottom section.

You will notice there is a red or blue selection box around either the top or bottom view; this indicates which section is selected. To go to full screen mode in one of the views, select a view by touching it then touch again to go full screen.

To take a capture without leaving split screen mode, select the view you wish to take a capture from by touching it, then touch and hold your finger in the view to take the capture.

VIEWING DISTANCE CAMERA IMAGES

Pictures taken with the Distance camera can be viewed in the Gallery similarly to the pictures taken with the Magnifier.

To view pictures taken with the distance camera:

- Select and tap on the Gallery icon in the carousel menu.



- Swipe right until you have selected the Distance camera picture icon (a spyglass in front of a folder), then tap once.



- The currently selected document is in the center of the screen. Prodigy Connect will announce and indicate the date the picture was taken.
- Swipe left or right to scroll through the available pictures.
- To open a selected document, simply tap.

READING WITH THE DISTANCE CAMERA

To read a picture taken with the distance camera, you will need to transfer the picture from the Distance category to the root of the Gallery.

- In the Distance category of your Gallery (a folder with a spyglass), hold your finger on the image you wish to move.
- Tap Move to Gallery.
- Your image should now be in the root of your Gallery where it can be read just like any other document.

REMOVING DISTANCE CAMERA FROM STICK

Your Distance camera comes already attached to the camera stick. If you wish to remove it from the stick, do the following:

- Make sure your camera is turned off.
- With one hand, firmly hold the camera.
- With your other hand, locate the thumbscrew located underneath the camera, and begin loosening it until the camera is detached from the stick.

Warning: The camera is very fragile, so make sure you are holding it properly before removing it from the stick.

VIEWING TEXT FILES IN PRODIGI

Prodigi Connect allows you to paste text files into the gallery and then open them using the Prodigi Connect interface.

To paste a text file in Prodigi:

- Copy to your tablet's clipboard the text you wish to add to Prodigi. This can be done outside Prodigi in Android applications that allow you to copy text (e.g. your internet browser, Dropbox or your emails.).
- Tap Back to open the Carousel menu.
- Select and tap on the Gallery icon in the carousel menu.



- Swipe until the Text icon is selected, then Tap to open the text section of the Gallery.



- Swipe until the Paste icon is selected, then Tap to paste the text you copied earlier:



- Your text will appear in Diamond Edge in column reading mode (original layout and images are not available).
- Tap back to return to the Text section of the Gallery.
- The text you pasted will now be saved in the Text section of the Gallery and will be named after the first word of your text.

EXAM MODE

The Exam mode is used to block certain functions and applications from the Connect 12 for a certain amount of time. While the Exam Mode is activated, the blocked functions and applications can only be accessible by entering a predetermined PIN number or by waiting for the time to run out.

To activate the Exam Mode on the Connect 12:

- From the Carousel menu, select the Settings icon:



- In the Settings menu, select the Exam Mode item. A submenu will be displayed on the screen.
- In the Exam Mode submenu, you can adjust the parameters by tapping on them and modifying their value. The adjustable parameters are the following:
 - Start Time.
 - Duration: Select a value between 30 minutes and 8 hours.

- Exit to Android: Tap to enable the access to the Android application while the Exam Mode is on. Tap again to disable it.
- Capture & Gallery: Tap to enable the access to the Gallery and the use of captures while the Exam Mode is on. Tap again to disable them.
- Calculator: Tap to enable the access to the Calculator while the Exam Mode is on. Tap again to disable it.
- Once you have adjusted all the parameters, tap the Exam Mode: off item on your menu to toggle the Exam Mode to on.
- Tap the Back icon at the top left of your screen.
- You will be prompted to enter a PIN code to deactivate the Exam Mode.
- The Exam Mode is now ready for use.

If you wish to change the parameters of the Exam Mode while it is activated, or to deactivate it, follow these steps:

- Access the general settings by tapping the Settings icon in the Carousel menu.
- In the Settings menu, select the Exam Mode item.
- You will be prompted to enter the PIN number you created when activating the Exam Mode.
- You now have access to the Exam Mode submenu, where you can change the parameters or deactivate the Exam Mode.

OCR LANGUAGE SELECTION

Prodigi allows the use of Optical Character Recognition (OCR) through various languages while using the Magnifier or the Camera.

To enable/disable the OCR:

- Tap on the Settings icon in the button banner from the Magnifier Application.



- Scroll and tap the item 'OCR: Disabled' in the Settings menu to enable the feature. If OCR is enabled, tap the item to disable it.

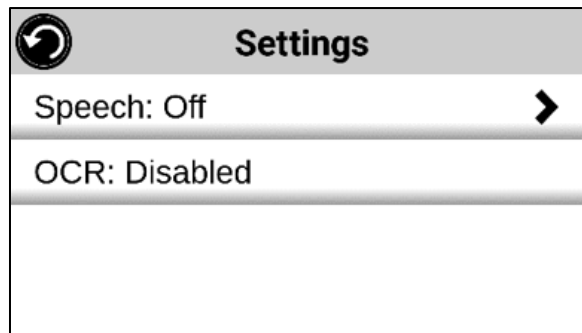

- Prodigi will automatically display a new item in the Settings menu: 'OCR languages: Installed voices'.

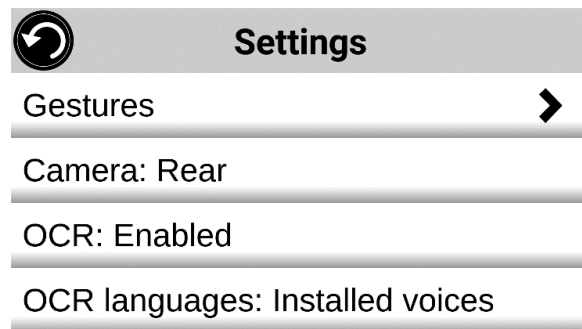

- Tap on this new item to change the Language feature to 'Custom'.
- The item 'Choose OCR Languages' will appear. Tap to open it. A list of the available languages will appear.

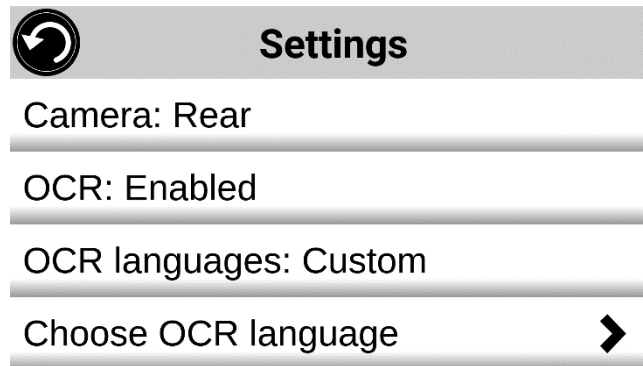

- Choose the language of your choice from the list.
- Press the Back button until you reach the Magnifier Application.

CHAPTER 4: CHOOSING YOUR CONTRAST

Prodigi allows you to view documents, pictures and objects in 3 types of contrast: **color**, **positive** or **negative**. For documents containing text, a 4th type of contrast can be used: **Diamond Edge™**. Positive, negative, and Diamond Edge contrasts are enhanced; they are meant to enhance the original color of a document or object to facilitate your visual experience.

Toggle between the different contrasts by swiping on the right edge of the touchscreen while magnifying or viewing an image or document:

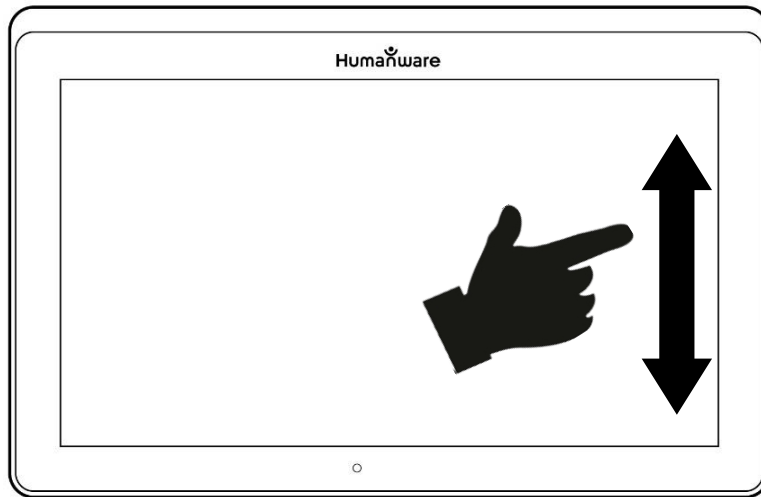

Alternatively, tap the Settings button while magnifying, viewing an image or reading, select Contrast, and swipe to choose a contrast. Tap Back twice to return to your document or object.

Color contrast is useful if you want to view documents, objects, and photographs in their original color.

Positive contrast shows text and images in 2 colors according to your selected color combination, the default combination being Black on White. This is a practical way to view text in the best color combination for your vision.

Negative contrast shows text and images in reversed contrast as compared to your selected color combination. For example, if your combination is Black on White, negative contrast will show text and images in White on Black. This is useful if you wish to reverse the contrast of a text that contains different contrasts.

Diamond Edge contrast combines the best of both worlds; it shows Diamond Edge Text™ in your selected color combination and images in their original color. This allows you to magnify text indefinitely without compromising its quality in the best color combination for your vision, while viewing images in their original color on the same page.

CHAPTER 5: STANDARD MODE (TILE)

The Tile Mode is one of the three types of User interfaces that can be used to navigate the Connect 12, along with the Carousel Mode (by default) and the Simple Mode. The Tile Mode menu allows you to customize the access to the applications you use the most on your Prodigy.



To activate the Standard Tile Mode:

- From the Carousel Menu, swipe and select the Settings icon and tap. Tap User Interface, select and tap

Interface: Standard (Carousel), tap on Standard (Tile) and tap Back three times to access the Tile Mode menu:

- The Prodigy applications are now accessible in a series of screens rotating like the Carousel Menu, but displaying six applications per screen rather than one by one. The 9 main Prodigy applications are accessible by default in the Tile menu. You will also be able to see the time and date.
- Swipe left or right in the Tile menu or tap on the right or left arrow on the side of the screen to go to the next application screen.
- To launch an application, simply tap on the application.

If you wish to add an application to the Tile menu:

- Tap on the Add icon:



- A new menu appears, offering two different options to access the application you wish to add to the Tile menu: Search and Show All.
 - The Search option allows you access the application you are looking for by typing its name.
 - The Show All option displays a list of all the installed apps on your Prodigy.
- Once you find the application you were looking for, you can add it to the Tile menu by simply taping on its icon.

- If you wish to remove an application from the Tile menu, simply press and hold on the application icon, then tap on delete.

CHAPTER 6: SIMPLE MODE

The simple mode allows you to access Prodigy's applications from the same screen. By default, Prodigy is set to standard mode.

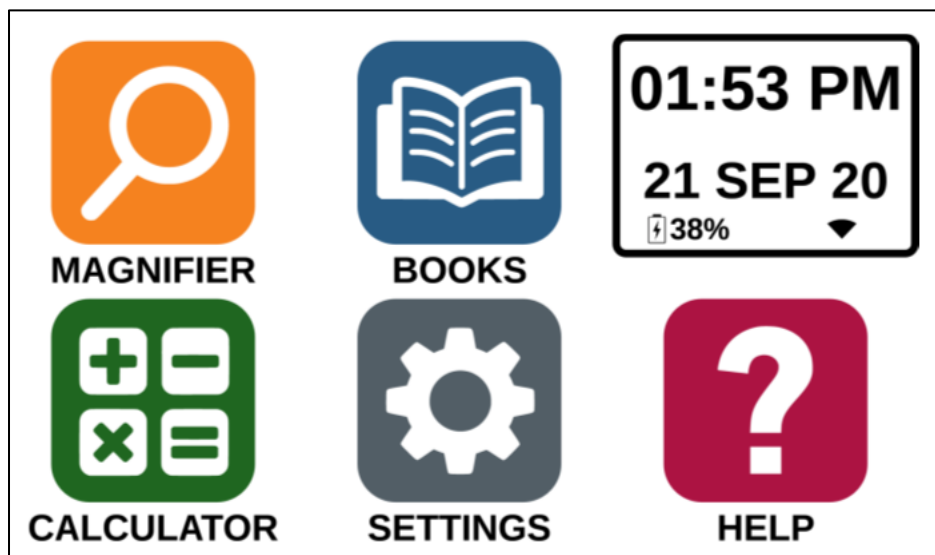

To activate the Simple Mode:

- From the Carousel menu, swipe and select the Settings icon and tap User Interface. Select and tap Interface: Standard (Carousel), tap on Simple and tap Back three times to access the Tile Mode menu:
- The Prodigy applications are now accessible from the same screen. You will also be able to see the time and date.
- To launch an application, simply tap on the application.

CHAPTER 7: CHANGING YOUR SETTINGS

Prodigi's settings menu is contextual; different settings will be displayed depending on what you are doing or where you are in the system.

To access the settings, tap the Settings button. Swipe down to see the battery level, and swipe up to select an item. The currently selected item is announced and highlighted by a frame. Scroll up or down to move the frame and select an item. The items will be read one at a time (by default). Tap to toggle the value or swipe when in a list of values. Tap Back (top left corner) to return to what you were doing.

Note: Your navigation mode will be different if your Speech setting is set to "Off" or "Documents only". There will no longer be a frame, and each menu item will have a shadow below it. In this navigation mode, you can simply touch an item to select it instead of highlighting it with the frame.

Here is a list of Prodigi's contextual settings:

(The values marked with a star (*) are default settings.)

- **Brightness:** 0 to 100% (50%*)
- **Contrast:** Diamond Edge (if captured image contains text), Color*, Positive, Negative
- **Colors** (Select from 20 color pairs): Black on white*, White on black, Black on gray, Gray on black, Black on yellow, Yellow on black, Black on orange, Orange on black, Black on cyan, Cyan on black, Black on purple, Purple on black, Black on green, Green on black, Blue on yellow, Yellow on blue, White on blue, Blue on white, Beige on black, Black on beige

- **Mode** (Standard mode only): Live*, Multi-Capture
- **Autofocus** (Live mode only): Locked, Unlocked*
- **Angle Correction:** Enabled*, Disabled
- **Speech:** On, Documents only, Off*
- **Voice:** Voice 1*, Voice 2, Voice 3, Voice 4 (4 voices maximum)
- **Speech Rate:** Very slow, Slow, Normal*, Fast, Very fast
- **Reading Mode:** Page, Column*, Line
- **Reading Speed:** Very slow, Slow, Normal*, Fast, Very fast
- **Diamond Edge:** Always*, On Request
- **Font Type:** Regular, Bold*
- **Preferred Zoom:** 2x to 35x (4x*)
- **Font Size:** Minimum, Small, Medium, Standard*, Large, Very large, Extra large, Maximum
- **Highlight** (Column and Line modes only. Highlight on spoken words): Display*, Hide
- **Delete Gallery content** (in Gallery): Permanently delete all files in Gallery. Press the Settings button in the Gallery to reach this option.
- **Wi-Fi Setup:** Press the Settings button to reach this option.
 - **Wi-Fi:** Turn Wi-Fi On or Off.
 - **Wi-Fi Networks:** List of available networks. When connected, shows network you are connected to. More advanced options can be available when selecting a network:
 - **Advanced options/Proxy:** Allows you to configure a proxy connection
 - **Advanced options/IP Settings:** Displays the host configuration protocol for the selected network

- **Saved Networks:** Saved networks configurations. To forget a network configuration, tap network, tap Forget, and tap Yes.
- **Mode** (in Calculator app, press the Settings button to reach this option): Standard*, Scientific
- **Grid** (in Calculator app, press the Settings button to reach this option): Locator color*, Red, Orange, Yellow, Purple, Cyan, Green, Blue
- **Gestures** (while magnifying, viewing an image, or reading a document, allows you to enable/disable gestures. They are checked by default):
 - **Swipe on left edge / Mode:** Toggle between Live and Multi-Capture modes.
 - **Swipe on right edge / Contrast:** Toggle between Color, Positive, Negative, and Diamond Edge contrasts (The last selection will be saved in Prodigy's memory).
 - **Pinch and zoom:** Adjust the zoom level by decreasing or increasing the distance between 2 fingers.
 - **Double tap:** Access the carousel menu or toggle between Speech On and Off while reading by tapping twice quickly with 1 finger.
 - **Tap / Zoom:** Press your finger down quickly on the touchscreen (tap) to zoom at your preferred zoom level.

You can access other general settings from the carousel menu by tapping the Settings icon:



You will see 5 main menus and 1 item: User Interface, Audio, System, Applications, Exit to Android, and About. Scroll up or down in the Settings to select a menu or item. Prodigy will announce “submenu” if a selected menu contains submenus and display an arrow on the right edge of the screen. To open a menu, submenu, or an item, simply select it and tap. Once you have reached the setting you want to modify, tap or swipe up in a list of values. Tap Back to return to a previous screen. Tap and hold the back button to exit the Settings from anywhere in the Settings menu.

Here is a list of Prodigy’s general settings:

(The values marked with a star (*) are default settings.)

User interface:

- **Interface:** Standard (Carousel)*, Standard (Tile) and Simple
- **System Language:** Language 1*, Language 2, Configuration (will connect to the Internet to find downloadable language packs)
- **Colors** (See color pairs above in contextual settings)
- **Locator color:** Red*, Orange, Yellow, Purple, Cyan, Green, Blue
- **Screen Brightness** (Change the screen’s brightness level): 1 to 100% (60%*)
- **Button Banner:** Auto*, Hidden, Always
- **Tablet Vibrations:** On*, Off

Audio:

- **Speech:** On*, Documents only, Off
 - See section “[Speech On](#)” to use the Speech On mode

- **Speech Rate:** Very slow, Slow, Normal*, Fast, Very fast
- **Sounds:** On*, Off
- **Tablet/Base Volume:** 0 to 15 (9*)
- **OCR Sound:** On, Off*

System:

- **Wi-Fi Setup:**
 - **Wi-Fi:** Turn Wi-Fi On or Off.
 - **Wi-Fi Networks:** List of available networks. When connected, shows network you are connected to.
 - **Saved Networks:** Saved networks configurations. To forget a network configuration, tap network, tap Forget, and tap Yes.
- **Bluetooth Setup**
 - **Bluetooth:** Turn Bluetooth on or off. When turned on, your Prodigy Connect will both attempt to discover other Bluetooth devices and be discoverable by other devices.
 - **Paired Devices:** Devices currently connected to Prodigy
 - **Forget device:** Unpairs the device. The device will remain discoverable in the Devices submenu.
 - **Rename device:** Choose another name for the device.
 - **Reset name:** Reverts to the device's default name.
 - **Devices:** Nearby Bluetooth devices discovered by Prodigy.
- **Software Update** (see chapter 10)
- **Tablet Auto Shutoff:** 3 min*, 5 min, 10 min, 30 min

- **Restore to Factory Defaults**

Applications:

- **Books:** Checked*, Unchecked
- **Calculator:** Checked*, Unchecked
- **Distance:** Checked*, Unchecked (simple mode only)
- **Rapid Toggle:**
 - **Search**
 - **Select applications**

Exit to Android:

Exits Prodigy. You can return to Prodigy by pressing the Home button and tapping the Prodigy icon.

About:

- **Software** (Version)
- **Voices** (Version)
- **OCR** (Version)
- **Books** (Version)
- **Calculator** (Version)
- **Distance** (Version)
- **Prodigi Updater** (Version)
- **Serial Number**
- **Model**
- **Android** (Version)
- **Base** (Version)

Speech On:

When Speech is set to ON, the navigation will be significantly different. Prodigy will read systematically all items visible on the screen for a fully assisted guidance.

Within menus:

The Speech feature will read the number of items included in the menu and/or submenu selected and subsequently read the first item selected on the screen. If that item leads to another submenu, it will also read “submenu”.

For example: Settings Menu > 7 items > User Interface > Submenu

You can not directly touch a menu item to select it. You must swipe up or down to isolate the menu item you wish to select within the colored frame.

A 2-finger long press anywhere on the screen within a menu will isolate and highlight the “Back” navigation button. Once “Back” is highlighted, simply tap once anywhere on the screen and you will be brought back to the previous screen.

Within the tile / main menu:

The speech feature will read the application currently located within the colored frame.

For example, if you open your Connect 12 on the settings icon, the Speech mode will read: Main Menu > Settings.

To navigate to other applications, swipe left or right anywhere on the screen. Tap anywhere to launch the application in the colored frame.

To stop using the speech feature and resume back to normal navigation:

- Go to Settings.
- In the Settings, select the Audio item. A submenu will open.
- Select the Speech item.
- You are offered two options. Select Off if you wish to shut down the Speech feature completely, or Documents Only if you wish to use the feature only in documents.

CHAPTER 8: BLUETOOTH EXTERNAL KEYBOARD

With Prodigy Connect, you can type and navigate using your own Bluetooth keyboard.

THE HUMANWARE KEYBOARD

Though any Bluetooth keyboard will work, we encourage you to use the HumanWare keyboard shown below.

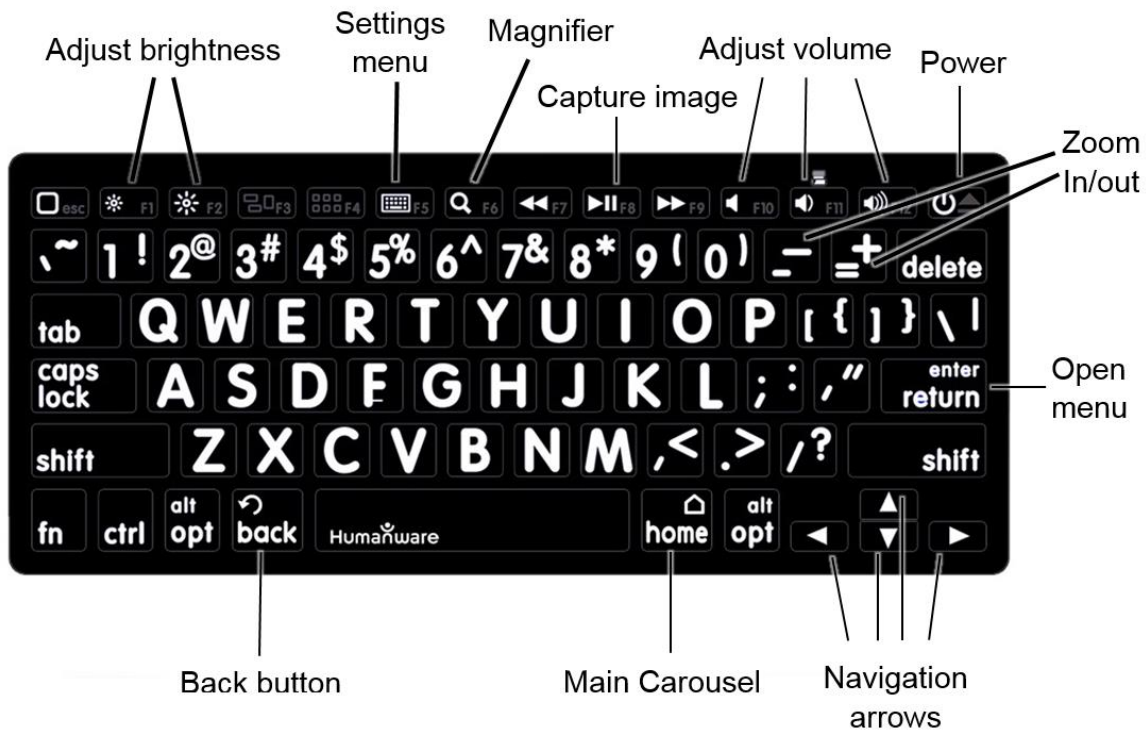

One of the advantages of using the Humanware keyboard is that all keys are printed in large, easy-to-read characters. In addition, icons of frequently used Prodigy commands are printed on the keyboard as a quick reminder of the key's function.

CONNECTING A BLUETOOTH KEYBOARD

To connect your Bluetooth keyboard to your Connect 12:

- Make sure your Bluetooth keyboard is turned on.
- Access the general settings by tapping the Settings icon in the Carousel menu.
- Select and enter the System submenu.
- Select and enter Bluetooth Setup.
- Bluetooth will be off by default. Turn it on by tapping the Bluetooth menu item. After a few seconds, additional menu items will appear and your tablet will become discoverable by other devices.
- Select and enter the Devices submenu.
- Select your Bluetooth keyboard and tap the screen.
- Tap Connect.
- Your Prodigy will display a PIN number. Type this number on your Bluetooth keyboard then press Enter.
- Your Bluetooth keyboard is now paired with your Prodigy Connect and ready for use.

CHAPTER 9: APH CODE JUMPER®

CONNECTING THE CONNECT 12 TO AN APH CODE JUMPER®

To connect an APH Code Jumper® device to your Connect 12:

- Make sure the Code Jumper® is turned on before establishing the connection.
- Access Prodigy settings by tapping the Settings icon in the main Carousel menu.
- Select and enter the System submenu.

- Select and enter Bluetooth Setup.
- Bluetooth will be off by default. Turn it on by tapping the Bluetooth menu item. After a few seconds, additional menu items will appear and your device will become discoverable by other devices.
- Select and enter the Devices submenu.
- Select your APH Code Jumper® device.
- Tap Connect.
- Your Code Jumper® is now paired with your Connect 12 and ready for use.

CHAPTER 10: ACCESSING ANDROID

Prodigi Connect allows you to access Android applications. Please note that HumanWare provides limited support for Android and Android applications.

Android is accessible from the Settings in the carousel menu. Tap the Settings icon and swipe down to select Exit to Android. You can also exit to android by placing and holding 4 or 5 fingers on the screen at the same time. This gesture is available anywhere in Prodigi. To come back to Prodigi once in Android select the Prodigi Icon.



Create a New User Profile

The Connect 12 device allows multiple user profiles to be created.

To add a new User Profile:

- Press and hold four or five fingers on your screen. A page displaying all the Android apps will appear.
- From the apps page, select Settings.
- In Settings, select the Users item.
- Select the Add user or profile item.
- Select the option User – Users have their own apps and content and tap on Ok.
- Press on the Set-up user now option that will appear on the screen.
- Follow the Android instructions to complete the user profile.

CHAPTER 11: HELP MENU

The rightmost item of the carousel menu is the Help Menu, where you will find many helpful videos showing you how to use your Connect. The Help Menu is represented by the question mark icon below:



Upon entering the help menu, you will have the following options:

Youtube tutorials: Here you have access to webinars and many useful tutorials on how to use your Connect tablet.

Make sure to check it out occasionally to see if there's anything new.

Feedback: Tell us what you think of your Connect, what you like, and how you think we could improve in the future.

CHAPTER 12: RECHARGING YOUR TABLET

Maximizing operating efficiency:

- In a working situation where you need the Tablet intermittently, you can enter Standby mode when you are not using the Tablet by pressing Power. The screen will power off.
- Wake Tablet by pressing the Power button.
- If you will not be using the Tablet for the next few days, it is recommended that you power it off by pressing and holding the Power button and selecting Power off.

Recharging the battery:

Tap the Settings button to enter the Settings menu and to display the Tablet's battery charge level. Swiping upwards in the Settings menu from the first item will announce the charge level (if Speech is set to On in the Settings).

IMPORTANT: The tablet becomes warm during recharging. Do not recharge the tablet near a heat source.

IMPORTANT: Do not close your folding stand while recharging. Doing so could damage your cable or the tablet.

To recharge the battery:

- Connect the power supply cable to the recharge port and plug it to an outlet.
- A full charge requires 4 hours.

Battery safety precautions:

- Do not disassemble or modify the battery.
- There is a risk of overheating, fire or explosion if the battery is put in a fire, heated, subjected to impact, put in contact with water, or if its terminals are shorted.

CHAPTER 13: RECHARGING YOUR DISTANCE CAMERA

Your camera has a battery life of 4 hours and will eventually need to be recharged.

Note: Help of a sighted person may be required to charge your camera.

To charge your camera:

- Carefully plug in the micro-USB connector into the slot located under the cap.
- Carefully connect the USB connector using the Tablet's charging block.

- The charge indicator will be orange when your camera is charging and turn green once the battery is fully charged.

CHAPTER 14: SOFTWARE UPDATE

SETTING UP YOUR Wi-Fi

Before initiating a software update, the Wi-Fi network needs to be configured.

- Tap the Settings icon from the carousel menu.
- Swipe to select System and tap.
- Tap to open Wi-Fi Setup.
- Select Wi-Fi Networks, and select the network you wish to connect to.
- Tap Connect. A keyboard will appear on the screen. Enter your password and tap on the blue button. Then, tap on Connect.

AUTOMATIC UPDATE

When Wi-Fi is configured, Prodigy will automatically check every week for updates.

If there is an update available, Prodigy will notify you and ask you if you wish to update your tablet. When this occurs:

- Tap Install to install the latest update. Prodigy will show the download progress.

- A new window will appear telling you that your software is now up to date. Tap OK to go back to Prodigy.

MANUAL UPDATE

At times, you may want to manually update your Prodigy tablet.

- Access the settings from the main menu, then select System.
- To initiate a software update, select Software Update and tap.
- Prodigy will verify if your software is up to date or if an update is available.
- If an update is available and you wish to install it, tap Install. If you wish to cancel, tap Cancel.
- If you chose to install the update, Prodigy will download the update and show the download progress.
- A new window will appear indicating that your software is up to date. Tap OK to go back to Prodigy.

RELEASE NOTES

To view the Prodigy software release notes:

- Access the settings from the main menu, then select System.
- Select software update.
- Select Release notes, if available.

CHAPTER 15: TROUBLESHOOTING

If the screen is blank:

- Zoom out of the image for minimum magnification.
- The Tablet could be powered off or in Standby Mode. Tap Power to power it on or to exit Standby Mode.

If colors are difficult to detect:

- Check if you have sufficient ambient light.
- Choose a different contrast or color combination in the Settings.
- Adjust the brightness level in the Settings.

If there is a lot of glare:

- Tilt object in a different direction to reduce glare.
- Reduce the brightness level in the Settings.
- Reduce external lighting effects.
- If your captured image is too bright or uneven, turn off the light on the button banner and capture a new image.

If the image/text is out of focus or blurry:

- Use the Zoom In-Out buttons to zoom in and then out of the image to trigger the camera's focus. If needed, capture a new image of your document.
- Make sure you hold the camera still while capturing an image.
- Make sure your Tablet is powered off, and wipe the LED lights and camera surface on the back side with a cleaning tissue.

If the audio reading does not make sense:

- Make sure the voice setting is the same as your document's language. Change it in the Settings if necessary.

If the Tablet is not responding:

- Make sure the battery is not empty. Recharge it if necessary.

Other problems:

- Restore Prodigy's default settings in Prodigy's menu. This will cause you to lose your preferences in Prodigy.
- Reset the Android system completely

WARNING: This will cause you to lose your settings and personal data.

IMPORTANT: It is highly recommended that you remove any saved Gmail account from your tablet prior to resetting the Android settings, as you will not be able to do so after the system reset. Additional fees may apply if you need to return your tablet to HumanWare to remove the saved email account.

To remove the saved Gmail account:

- Open the **Android Settings** and go to **Accounts/Google**.
- Tap the **three vertical dots** in the top-right corner of the screen.
- Tap **Remove account**, then confirm you wish to remove the account.

To completely reset the Android system:

- Open the **Android Settings** and go to **Backup & reset**.
- Tap on **Factory data reset**.
- Confirm you wish to reset the Android system.
- If all else fails, please contact your dealer or technical support.

Customer support

For customer support, please contact the HumanWare office nearest you or view our Website at:
www.humanware.com

North America: 1 (800) 722-3393
support@humanware.com

Europe: (0044) 1933 415 800
eu.support@humanware.com

Australia / Asia: (02) 9686 2600
au.sales@humanware.com