

# MATT Connect™

## User Guide



An APH / HumanWare Partnership Product.

**Humanware™**  
see things. differently.

**APH** AMERICAN  
PRINTING  
HOUSE



# Table of Contents

Chapter 1: Introduction .....	7
Chapter 2: Getting to Know Your MATT Connect .....	8
Box Contents .....	8
MATT Connect at a Glance.....	9
Setting Up .....	16
Chapter 3: Using the Prodigy Software.....	19
Initializing the MATT Connect Tablet .....	19
The Button Banner .....	19
User Interfaces.....	21
Basic Interface.....	21
Magnifying.....	22
Distance Viewing .....	22
Menus .....	22
Navigating Out of Basic Interface.....	23
Standard Interface .....	23
Magnifying.....	23
Viewing Captured Images .....	24
Distance Viewing .....	24
Menus .....	24
Navigating Out of Standard Interface.....	25
Advanced Interface.....	25
Magnifying.....	25
Capturing .....	27
Full Page Capture .....	28

Multi-Capture .....	29
Reading .....	30
Handwriting Tool .....	33
Configuring and using the Rapid Toggle Feature.....	36
Activate the Blue Light Filter .....	37
Using the Carousel Menu .....	38
The APH Toolbox.....	39
Downloading Books .....	40
Go to page feature .....	42
Annotate a book.....	43
Bookmarks .....	44
Using the Calculator.....	46
Graphic Calculator Powered by Desmos .....	47
Dictionary Tool .....	48
Viewing Saved Documents .....	51
The Gallery Settings Menu.....	52
The Action Menu.....	52
Add a function graph in a document .....	55
Navigating Out of Advanced Interface .....	57
Using the Distance Camera .....	57
Toggling between Distance Camera and Magnifier .....	59
Using Distance Camera and Magnifier Simultaneously ....	59
Writing Notes .....	59
Viewing Distance Camera Images .....	60
Reading with the Distance Camera.....	61
Removing Distance Camera from Stick .....	61

Viewing Text Files in Prodigy .....	61
Exam Mode .....	62
OCR Language Selection .....	64
Chapter 4: Choosing Your Contrast .....	65
Chapter 5: Changing Your Settings .....	67
Chapter 6: Bluetooth External Keyboard .....	72
Chapter 7: APH Code Jumper® .....	73
Connecting the MATT Connect to an APH Code Jumper® .....	73
Chapter 8: Accessing Android .....	74
Chapter 9: Help Menu .....	74
Chapter 10: Recharging Your MATT Connect .....	75
Chapter 11: Recharging Your Distance Camera .....	76
Chapter 12: Software Update .....	77
Setting Up Your Wi-Fi .....	77
Automatic Update .....	77
Manual Update .....	77
Release Notes .....	78
Chapter 13: Troubleshooting .....	78



# Chapter 1: Introduction

Thank you for purchasing the APH MATT Connect™ running the Android operating system with Prodigy™, the touch-controlled personal vision assistant system from HumanWare, a global leader in assistive technologies for people who have low vision.

Carefully read the operating and safety instructions described in this user guide prior to using your MATT Connect. If you have any questions about your system, please contact HumanWare Customer Service by consulting the contact information in the back of this user guide.

Copyright 2022 by Technologies HumanWare Inc., and the American Printing House for the Blind all rights reserved. No part of this publication may be reproduced or distributed in any form or by any means, or stored in a database or retrieval system, without the prior written permission of Technologies HumanWare Inc., and the American Printing House for the Blind.

# Chapter 2: Getting to Know Your MATT Connect

## Box Contents

### Tablet Box

- MATT Connect with Prodigy
- USB to USB-C Cable
- AC Adapter
- Quick Start Guide
- User Guide
- Warranty Sheet
- Transportation Bag
- Bluetooth keyboard
- Screen protector
- Stylus
- Power Pack to extend battery life of Distance Camera
- Screwdriver, screw and one page insert explaining how to affix the tablet to the stand
- Protective leather case/sleeve

### Protective Carrying Case

- Folding Stand

### Distance Viewing (optional)

- Distance Camera
- AC Adapter
- USB Cable
- Camera Stick
- Camera Quick Start Guide
- Camera User Manual
- Warranty Card
- Service Card

NOTE: The wrist strap and cell phone clip may not be included with the optional distance camera as these items have been discontinued by the manufacturer.



# MATT Connect at a Glance

## Front Face

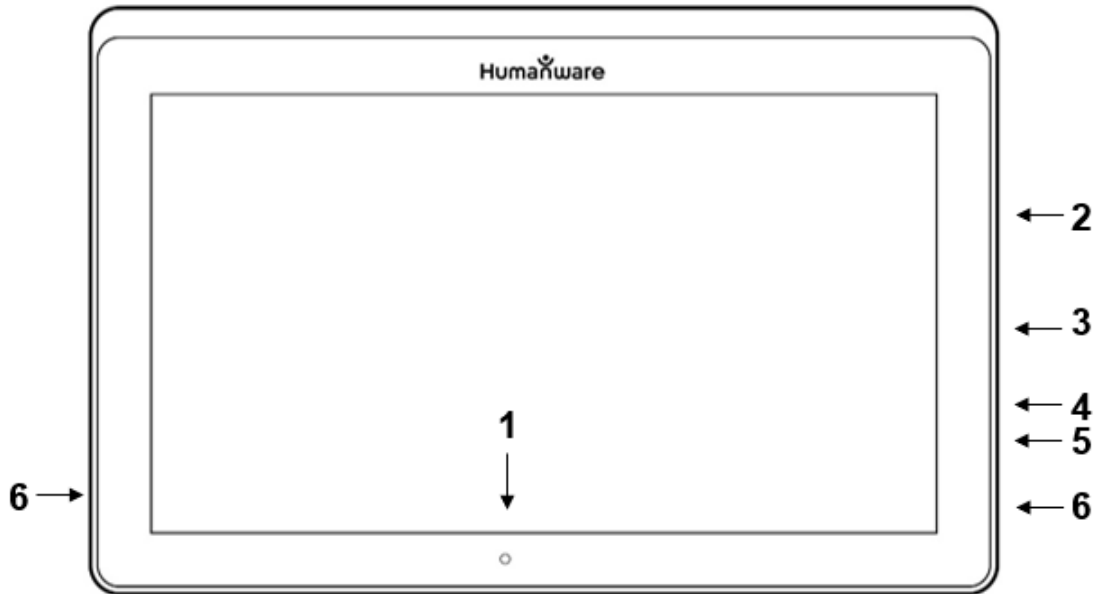

1. Front-Facing Camera
2. Micro-SD Slot
3. USB-C Port
4. Micro-HDMI Port
5. Headphone Jack
6. Speakers

## Bottom Edge

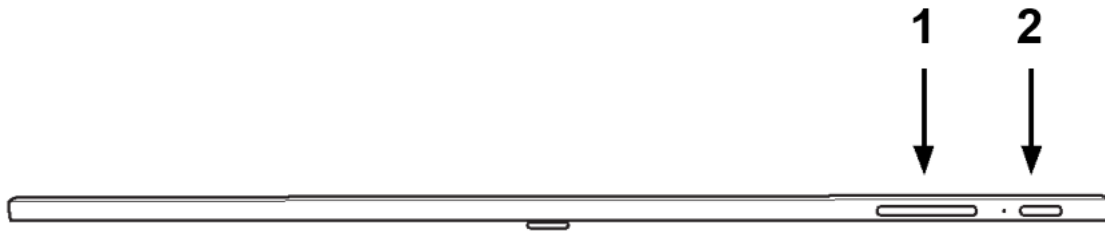

1. Volume Down-Up
2. Power Button

## Back Side

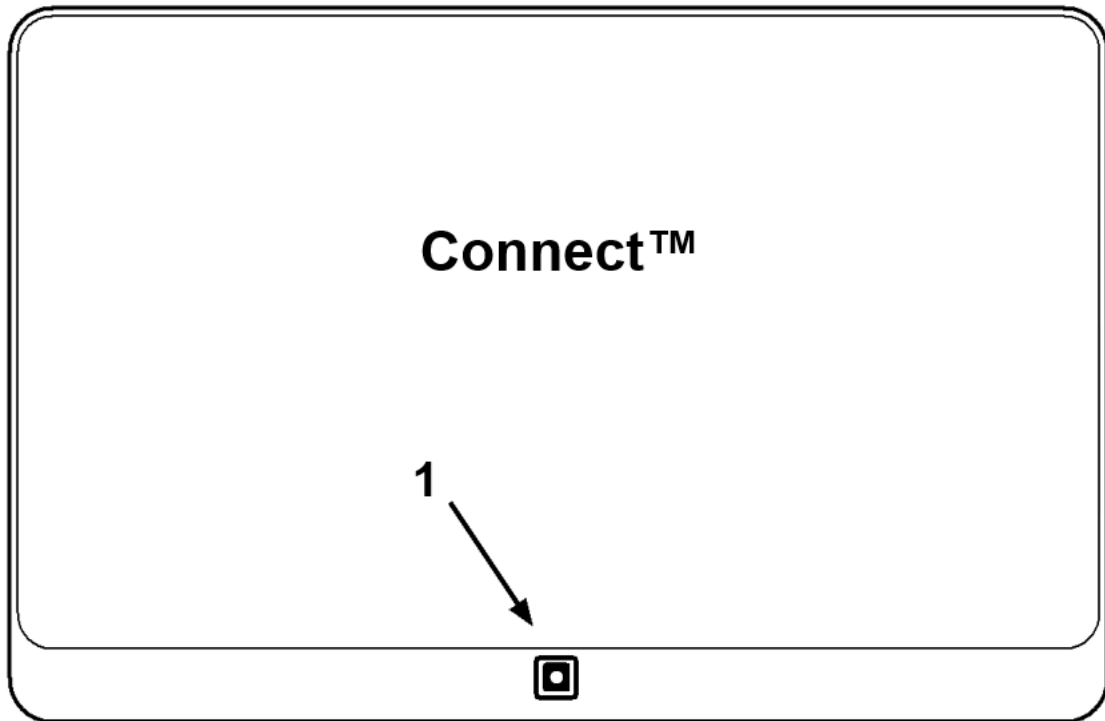

1. Camera

## Button Banner

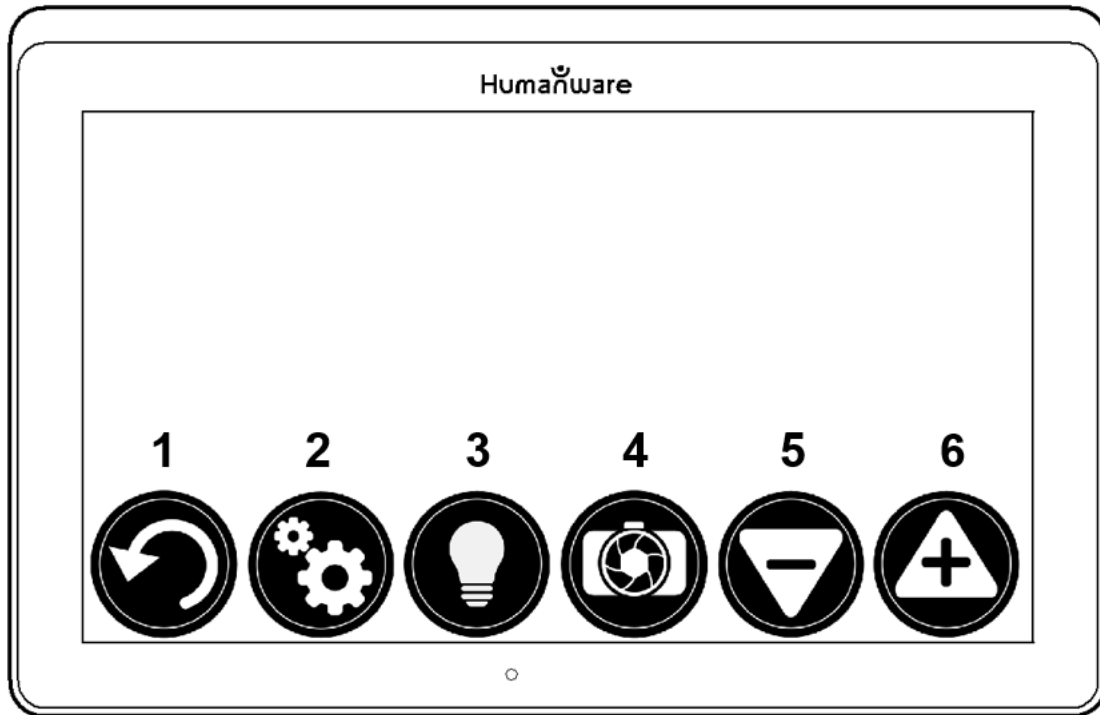

1. Back Button
2. Settings Button
3. Light Button
4. Capture/Read Button
5. Zoom Out Button
6. Zoom In Button

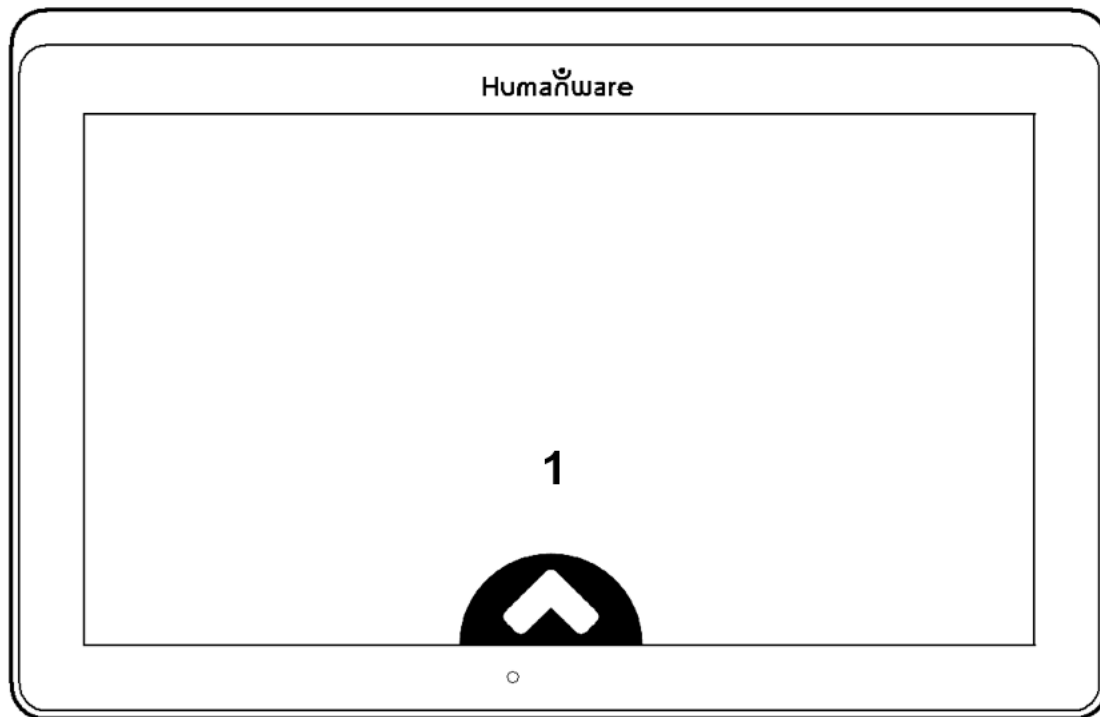

1. Open Banner Button

## Folding Stand

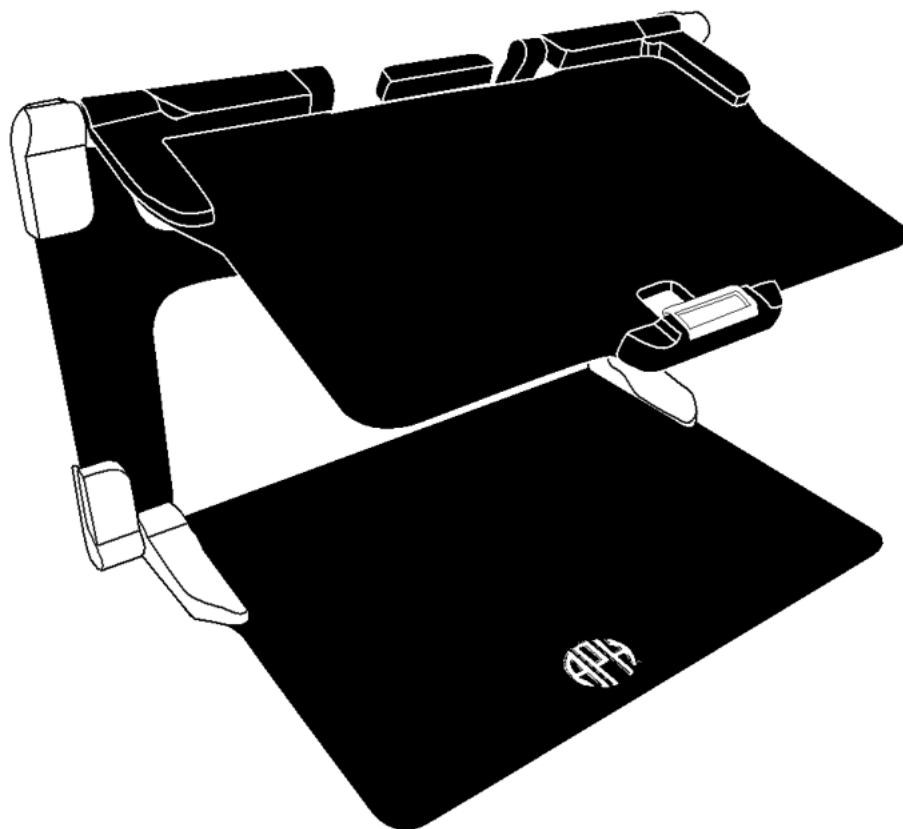

## Distance Camera

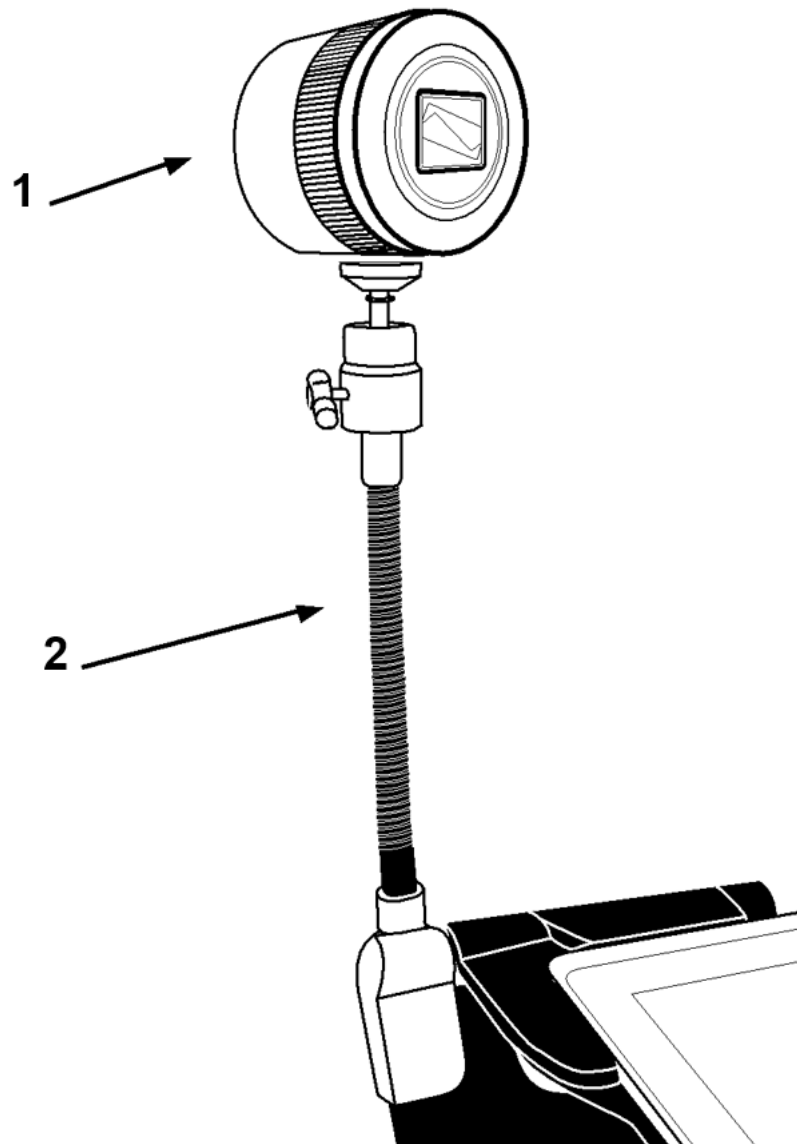

1. Distance Camera
2. Distance Camera Stick

## Front View

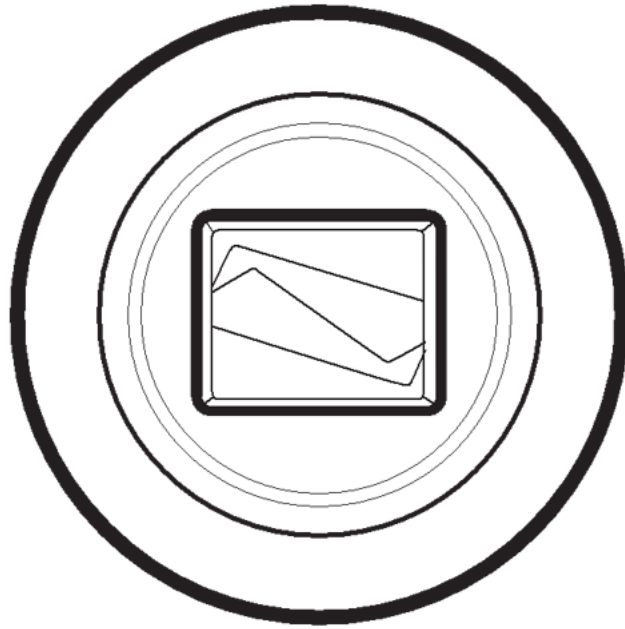

## Top View

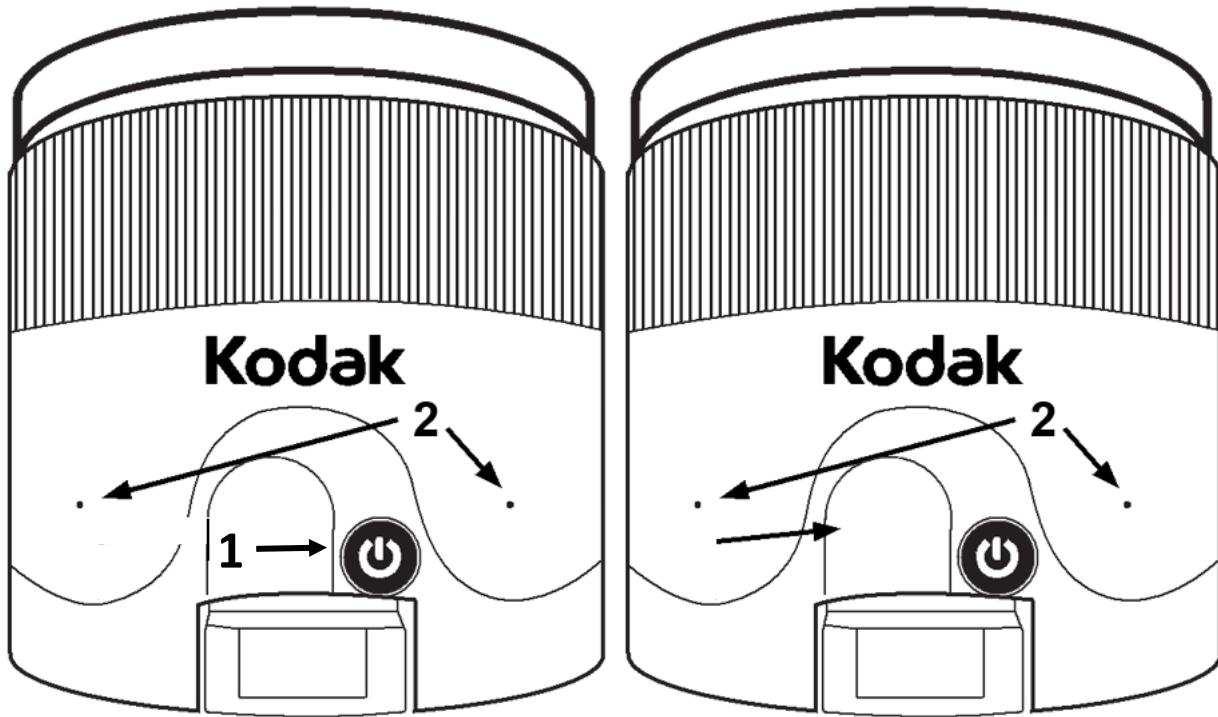

1. Power Button
2. Microphones

## Left View

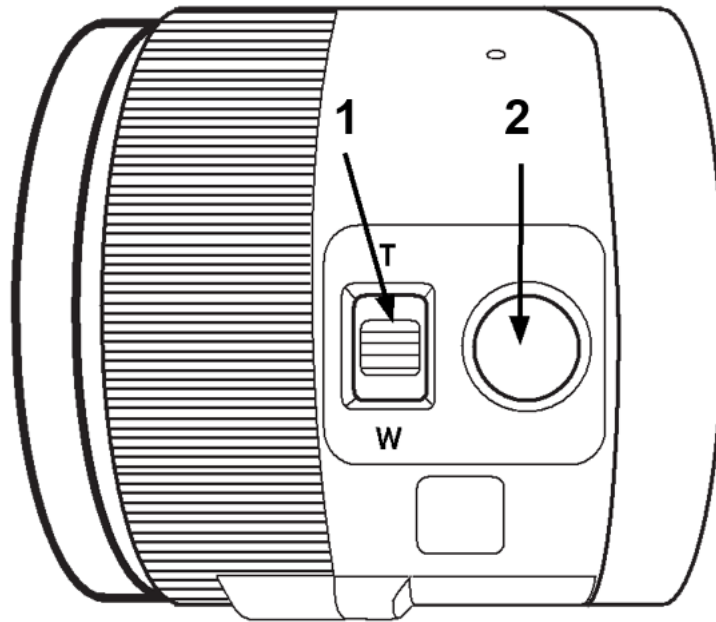

1. Zoom Lever
2. Shutter Button

**IMPORTANT:** It is essential to keep the Quick Start guide provided with your Distance Camera as it contains your camera's pairing information.

# Setting Up

1. On a flat and stable surface, hold your stand upright, making sure the panel with the words “MATT Connect” is facing towards the back. Hold the handle with one hand, and unfold the lower panel with your other hand until it is flat on the table.

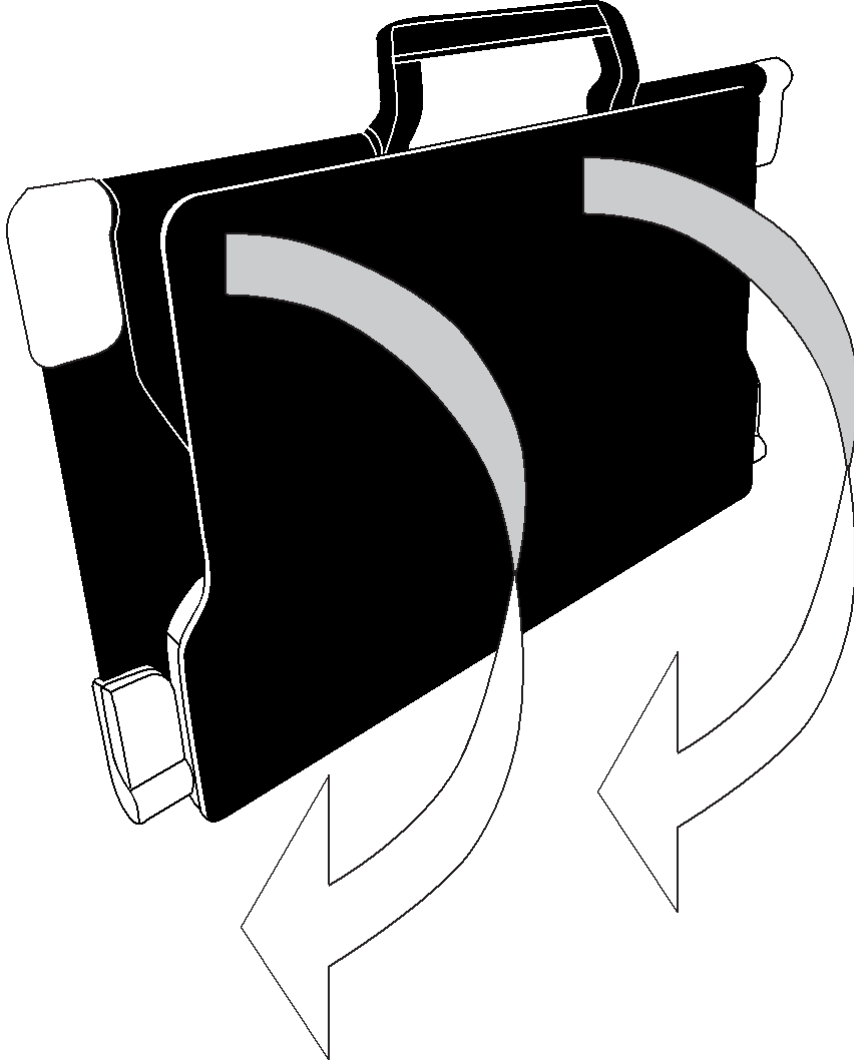



2. Lift and unfold the top panel until it is roughly parallel with the lower panel.

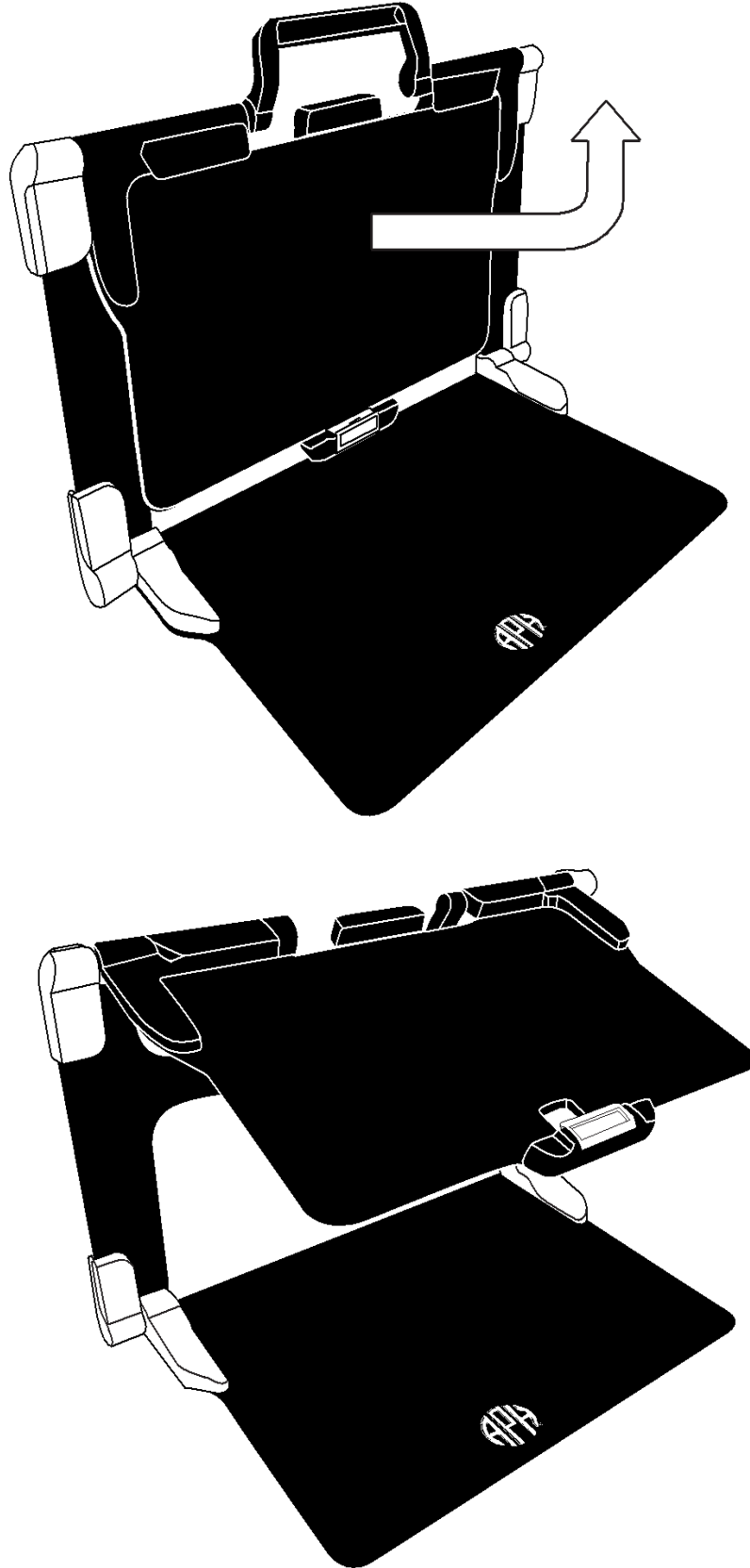

3. Hold your MATT Connect with the screen side facing you, making sure the HumanWare logo is at the top. Carefully insert the top of your tablet into the slot and slide it forward until you reach the back end of the slot. Push the bottom part of the tablet down; you will hear a click indicating that your tablet is fastened.



4. Connect the USB to USB-C cable to the USB-C port and plug it to an outlet using the power supply. The USB-C port is located on the right side of the tablet. Allow the tablet to recharge until the battery is full.

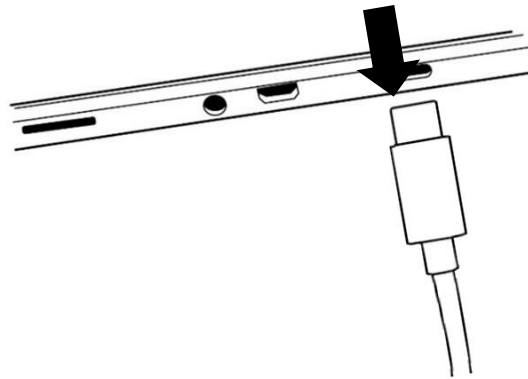

**IMPORTANT: Only use the power adapter and cable provided with MATT-Connect. Use caution while inserting the cable into the USB-C port.**

5. Press and hold the power button to power on your tablet. The HumanWare and Android logos will appear on screen. Your tablet will take about 30 seconds to initialize.

# Chapter 3: Using the Prodigy Software

## Initializing the MATT Connect Tablet

To access detailed videos of the tablet initialization process, visit the MATT Connect support page or YouTube channel.

[www.humanware.com/mattconnectsupport](http://www.humanware.com/mattconnectsupport)

Before the Prodigy software can be used the MATT Connect tablet must be initialized through the Android set-up wizard. This process is like setting up any new personal computing device. Be prepared with the following:

- Wi-Fi and network password information
- Google account information

The wizard will prompt you for Wi-Fi connection credentials, Google account information, and other legal requirements. It is highly recommended best practice to associate both Wi-Fi and Google accounts during this process, but not required. Some steps in this process may take a few minutes to complete, be patient.

Upon completion of the Android wizard, you will be prompted to install Prodigy. Follow the onscreen prompts to perform this action. Be patient, this may take a couple of minutes.

Once Prodigy is installed, the system will check for updates, then you will be prompted to choose a voice or voices (up to four) to install. Be patient, these may take a couple of minutes.

After Prodigy is fully installed, you will be prompted to choose your Home application. In most cases, you will want this to be Prodigy.

You can now access the Prodigy software.

## The Button Banner

Most of Prodigy's actions are performed through the Virtual Button banner located at the bottom of your screen.

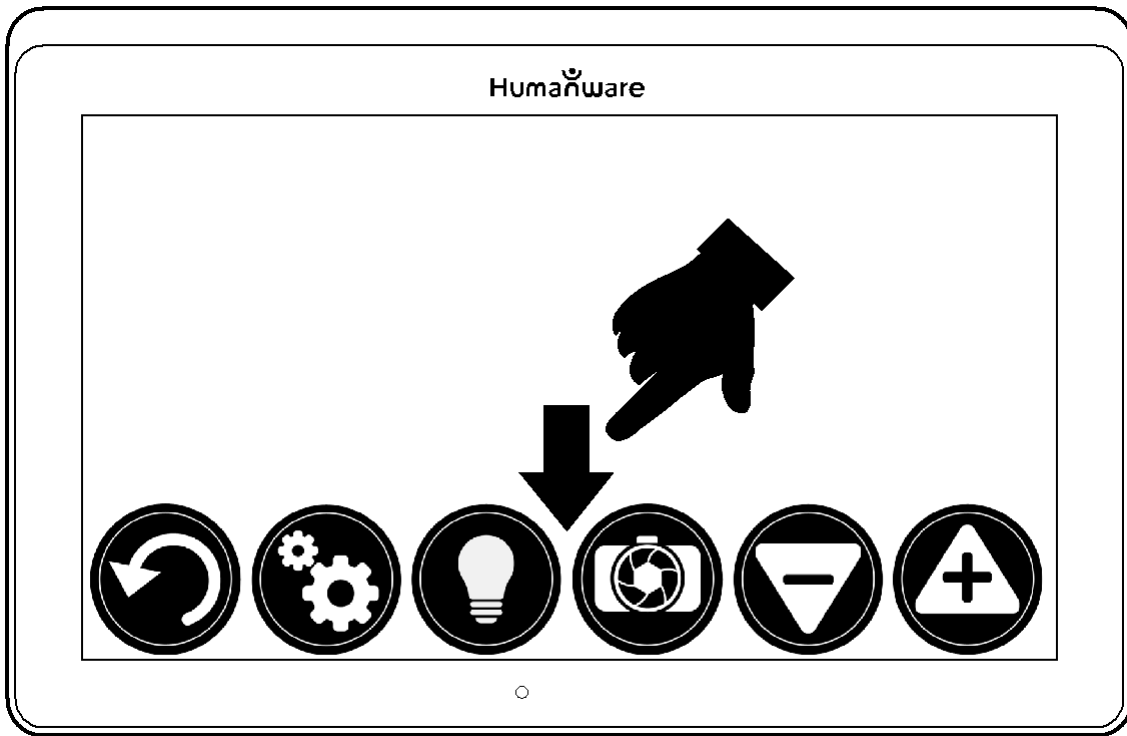

If you wish to hide this banner to better see your screen, do a **downward swipe** on the button banner (move your hand downwards while touching the screen with a finger). The banner will be replaced by the Open Banner button at the bottom of your screen.

Tap this button or **swipe upward** to display the Button Banner.

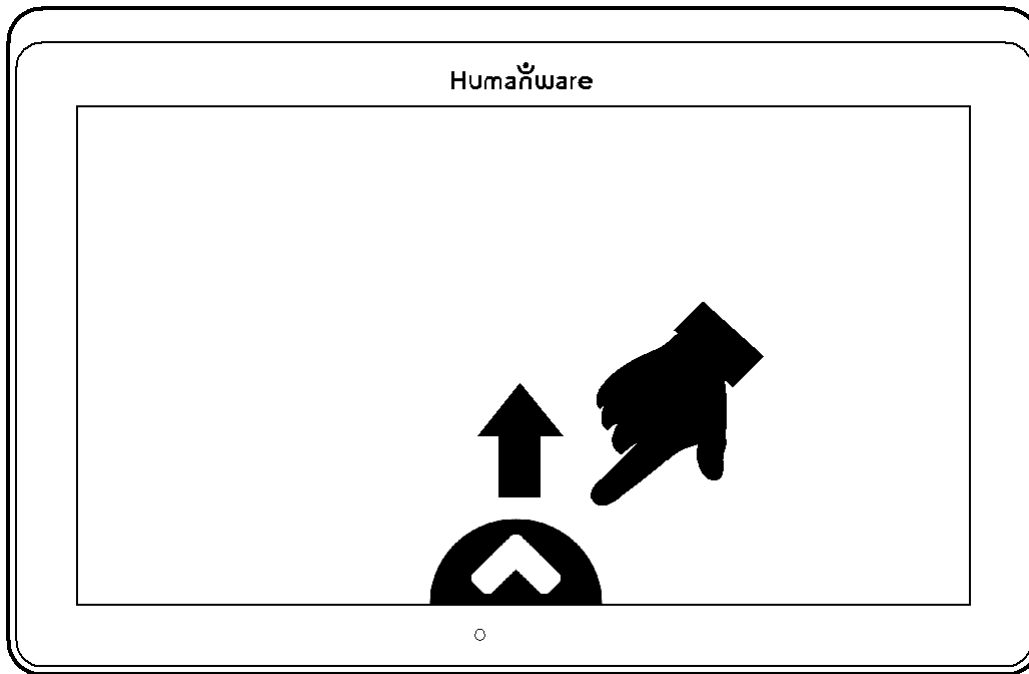

## User Interfaces

The Prodigy software provides three unique user interfaces designed to address the differing needs and skill levels of consumers. This chapter will discuss the capability of each interface and how to navigate between them.

Detailed information regarding menu options can be found in subsequent sections of this user guide.

### Basic Interface

The Basic Interface allows for magnification and distance viewing without additional features.

## Magnifying

Contrast button – cycles through selected contrast modes

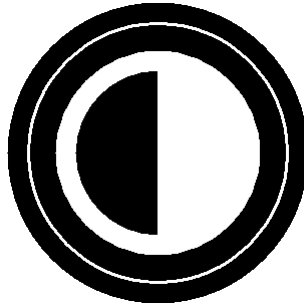

Distance button – switches to distance viewing

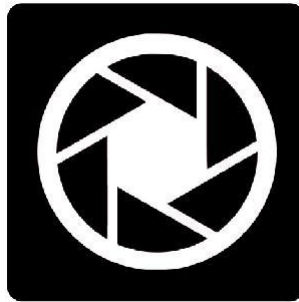

Zoom Out

Zoom In

## Distance Viewing

Back button – returns to magnification screen

Contrast button – cycles through selected contrast modes

Zoom Out

Zoom In

## Menus

To enter the Contrast and Settings menus press and hold the Contrast button for 3 seconds. There is also an option within this hidden menu to lock/unlock the camera's autofocus feature.

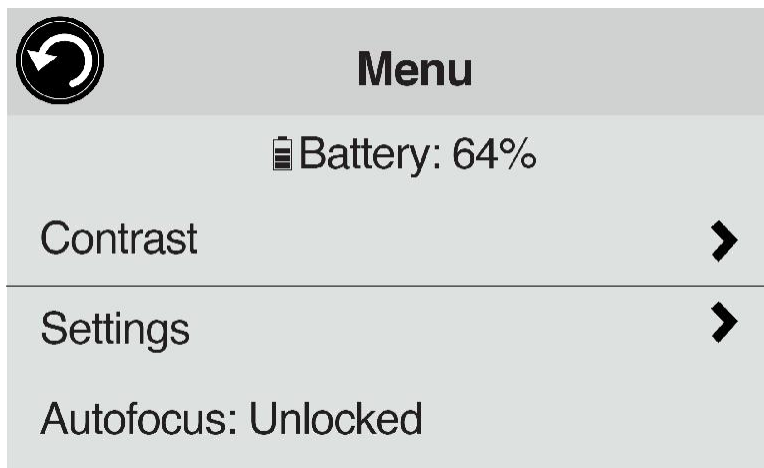

## Contrast Menu

Text & buttons – Navigates user to a list of color contrast options for on-screen text and buttons

Magnification – Navigates user to list of 20 color contrast options which can be added or removed from the cycling list accessed through the Contrast button

## Navigating Out of Basic Interface

From the Settings Menu, select User Interface; within this submenu, select Interface: Basic. This will display the different interface options for selection. Once you have chosen the desired interface, engaging the Back button will confirm the selection.

## Standard Interface

The Standard Interface extends the features to include image capturing and OCR reading.

## Magnifying

Gallery button – navigates to image gallery

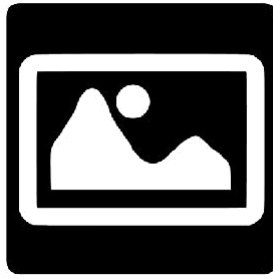

Contrast button – cycles through selected contrast modes

Distance button – navigates to distance viewing mode

Capture button – captures image on screen

Zoom Out

Zoom In

## Viewing Captured Images

Once you capture an image, the Capture button will now become the Read button. Tap the Read button or long press anywhere on the screen for 2 seconds to scroll and read aloud the text. Audio preferences can be found in the Settings menu.

## Distance Viewing

Back button – navigates back to magnifier mode

Gallery button – navigates to image gallery

Contrast button – cycles through selected contrast modes

Capture button – captures image on screen

Zoom Out

Zoom In

## Menus

To enter the Contrast and Settings menus press and hold the Contrast button for 3 seconds. There are also options within this hidden menu to delete the gallery content and lock/unlock the camera's autofocus feature.



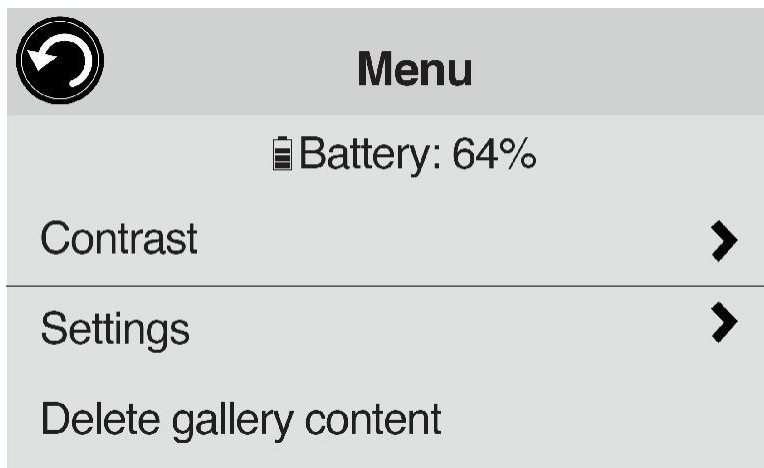

## Contrast Menu

Text & buttons – Navigates user to a list of color contrast options for on-screen text and buttons

Magnification – Navigates user to list of 20 color contrast options which can be added or removed from the cycling list accessed through the Contrast button

## Navigating Out of Standard Interface

From the Settings Menu, select User Interface; within this submenu, select Interface: Standard. This will display the different interface options for selection. Once you have chosen the desired interface, engaging the Back button will confirm the selection.

## Advanced Interface

This interface unlocks the full potential of the MATT Connect as discussed in the following sections. While operating in this capacity, users can access applications through the APH Toolbox and even exit the Prodigy software altogether.

## Magnifying

- Power on the tablet.
- Choose the rear camera if you wish to magnify an object or a document. Choose the front camera if you wish to view yourself. You can switch the cameras by tapping on the Settings icon, then toggle between the cameras by tapping on Front/Rear.

- If you use the “Rear” camera, align the tablet above the document or object you wish to view. It is recommended to use the folding stand to stabilize your tablet above the document you wish to view.
  - Move the object or document under your tablet to find the information you are looking for.
  - Tap the Light button to turn on the tablet’s light if the display is too dark.

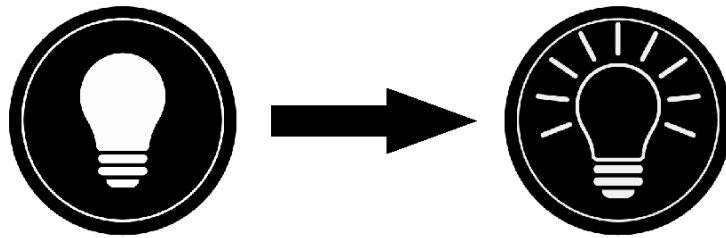

- If you use the “Front” camera, place yourself in front of the tablet for a mirror/self-view.
- Tap the **Zoom In-Out** buttons to adjust the zoom level. To increase character size, tap the **Zoom In** button (+). To decrease character size, tap the **Zoom Out** button (-). You can also tap and hold the Zoom In-Out buttons to progressively adjust the zoom level, and release once you reach your desired zoom level.

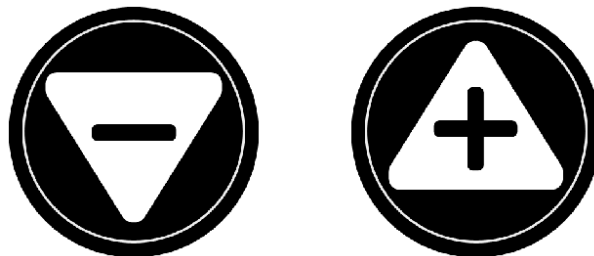

- In addition to the Zoom In-Out buttons, you can use the **pinch and zoom** gesture to adjust the zoom level. Decrease the distance between two fingers to zoom out, and increase the distance to zoom in:

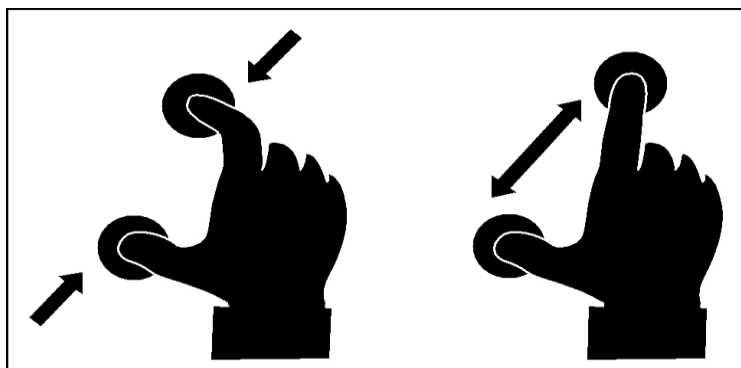

- To toggle between **color**, **positive**, and **negative** contrasts, simply swipe vertically on the right side of the tablet's screen (see Chapter 4: Choosing your contrast for more details).

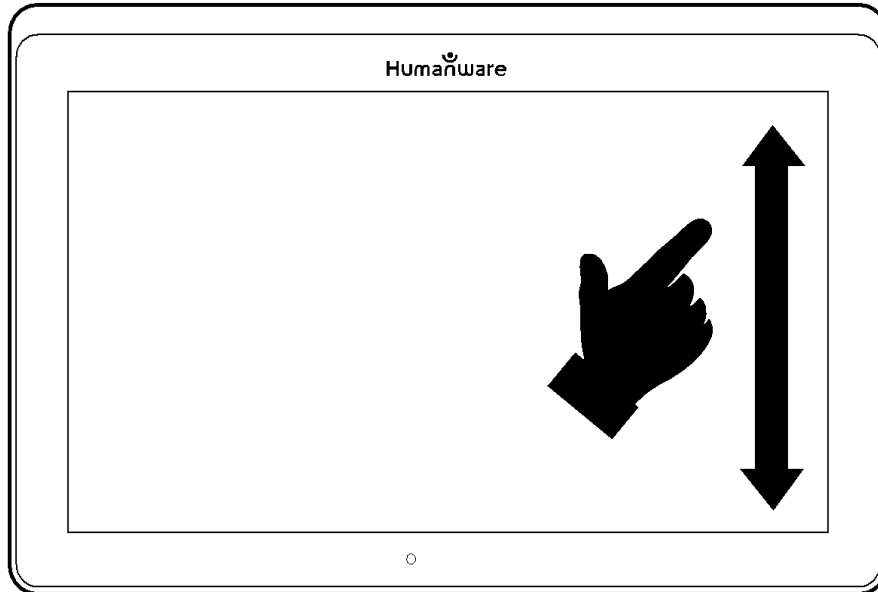

**Note:** Prodigy allows you to decide whether to lock or unlock the camera's autofocus. This is useful when the right focus is displayed for the document and you want to lock its position, or when you are performing a manual task like writing on a piece of paper, and want to prevent your tablet from refocusing on your hand or pencil, for example. To lock autofocus, simply perform a **double tap** gesture (tap twice quickly) anywhere on your screen. Double tap again anywhere on the screen to unlock autofocus. The following icon will appear on the right side of your screen when autofocus is turned off:



## Capturing

- Using the folding stand, position the tablet above the document or object you wish to capture.

**Note:** The tablet does not need to be perfectly aligned above your document; by default, the Prodigy software will automatically correct the angle of your tablet. On screen, two triangular shapes on each side of your document will indicate angle correction. You can change this by accessing the Settings. Tap the Settings button, swipe up to select Angle Correction, and tap to uncheck. Tap Back to exit.

- Tap the Capture button to capture your document or tap and hold your finger on the screen for 2 seconds.



- You will hear a picture sound, followed by a clicking sound; indicating that the document has been captured.
- Once you make a capture, the Light button will be replaced by the Save button. This button allows saving of capture in Gallery.

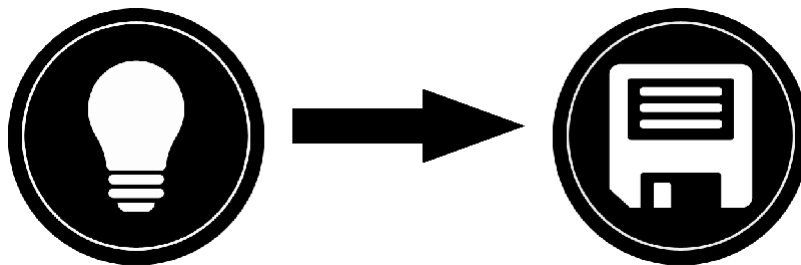

- Tap the Save button to save your document in the Gallery for future use.
- Tap the Back button if you want to return to Magnifier Live mode.

## Full Page Capture

To capture a full page:

- Instead of laying your sheet vertically, place your sheet sideways (landscape position) so that the top of your text is located under the left edge of your MATT Connect, and the bottom of your text is located under the right edge of your tablet.

- From Magnifier mode, tap the Zoom Out button once. This will activate full page view, turn on LED and reduce the button banner.
- Align your page visually under the stand so that all of the text is displayed on-screen.
- Long press to capture.

**Tip:** To capture more text, you can raise the tablet further from the document, allowing more view angle.

- To return to Live mode and capture smaller objects or documents, simply tap on the Button Banner button to open it and press the Zoom In button once.

## Multi-Capture

- To capture a multipage document, toggle to Multi-Capture mode by swiping vertically on the left side of the tablet's screen:

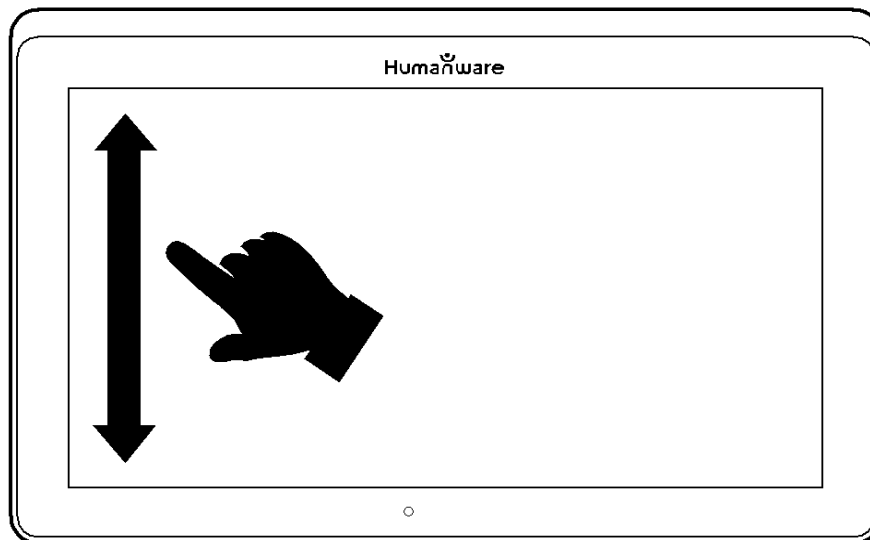

**Note:** You can also toggle to Multi-Capture mode from the Settings. Tap the Settings button, swipe up to select Mode, and tap to set it to Multi-Capture. Tap Back to exit the Settings.

- You can now capture a multipage document. Align the tablet above the first page of the document you wish to capture and tap the Capture button or press and hold your finger down on the screen. Proceed in the same way for each page you wish to capture. Your multipage document will be saved in the Gallery for future use.
- To end Multi-Capture and view your document, tap the top left Multi-Capture button.

- Tap on the first page of your document to open it. Tap the Read button to start reading.
- When you are done reading, tap the Back button to return to your document. Tap Back again to return to Magnifier mode.

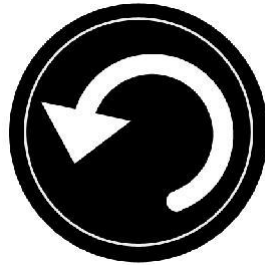

## Reading

Once you make a capture, the Capture button will change from a camera image to a play symbol. This is now the Read button.

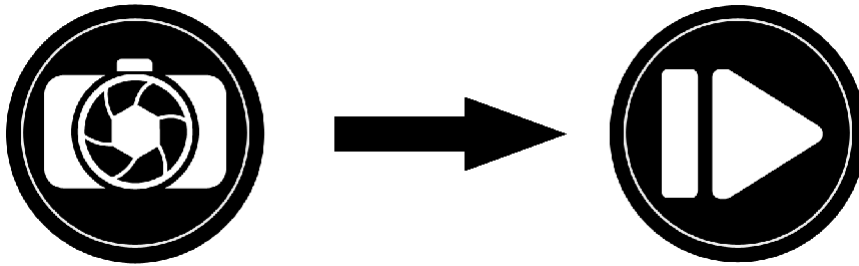

- Tap Read or long press anywhere on the screen for 2 seconds to scroll and read aloud the text according to your reading preferences.

**Note:** When you press read, the Button Banner will collapse to provide a better view of your image. It can be re-opened by pressing the Open Banner Button or by doing an upward swipe on the lower section of the screen.

- To adjust the volume, use the Volume Down-Up buttons.
- To pause, tap Read again or long press anywhere on the screen.

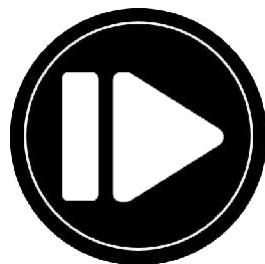

- While paused, tap Back to exit reading view, and Back again to return to the camera view.

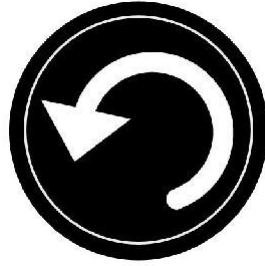

- To resume, tap Read again or long press.

When in magnifier mode, reading mode allows you to zoom in and out of your captured document.

To zoom in a captured document:

- Use the **Zoom In-Out** buttons to adjust the zoom level. To increase character size, tap the **Zoom In** button (+). To decrease character size, tap the **Zoom Out** button (-). You can also tap and hold the Zoom In-Out buttons to progressively adjust the zoom level, and release once you reach your desired zoom level.
- In addition to the Zoom In-Out buttons, you can use the pinch and zoom gesture to adjust the zoom level.
- To instantly zoom to an area of interest, perform a single tap on the area you wish to view and the image will zoom at that location at your preferred zoom level.
- If you are in a zoomed level over 1X, you can move around your zoomed document by doing a **Pan Gesture** (slowly move your finger on the screen without lifting it).

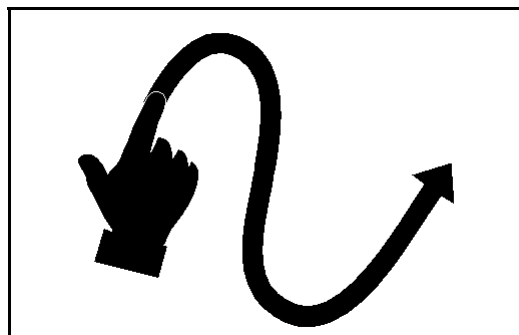

- Pan to reach other parts of the enlarged image.

- To toggle between the different contrasts, swipe on the right edge of the touchscreen or access the Settings (see Chapter 4: Choosing your contrast for more details).

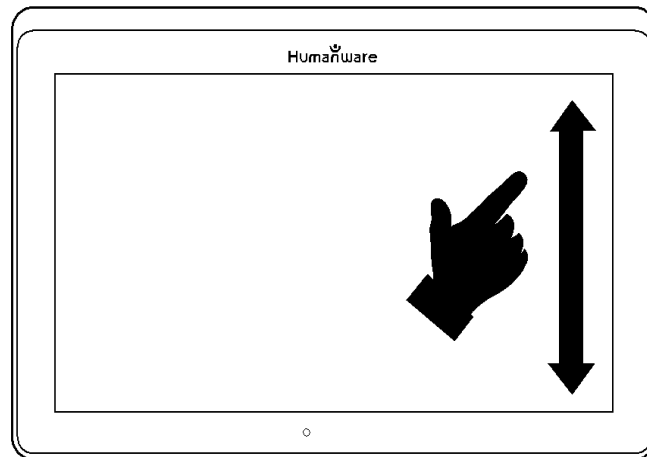

**Note:** Text can be presented in three different formats (Reading Modes): it can be changed in the settings to a single line in the Line mode, a column in the Column mode (default), or you can read text without losing its configuration in the Page mode. Two “greater than” signs will identify the end of a paragraph in the Line and Column modes (>>).

If speech is On, Prodigy will beep and announce “End of document” when you reach the end of your document; tap Read to start reading from the beginning again.

- To set a different Reading Mode, tap the Settings button and swipe up to select Reading Mode.



- Tap Reading Mode to toggle the value. Tap Back to exit the Settings.
- You can temporarily increase the speech rate while reading by swiping to the left (sliding and releasing your finger to the left) on the touchscreen, and decrease the speech rate by swiping to the right. Note that changing the speech rate will change the reading speed (text scrolling speed) accordingly.



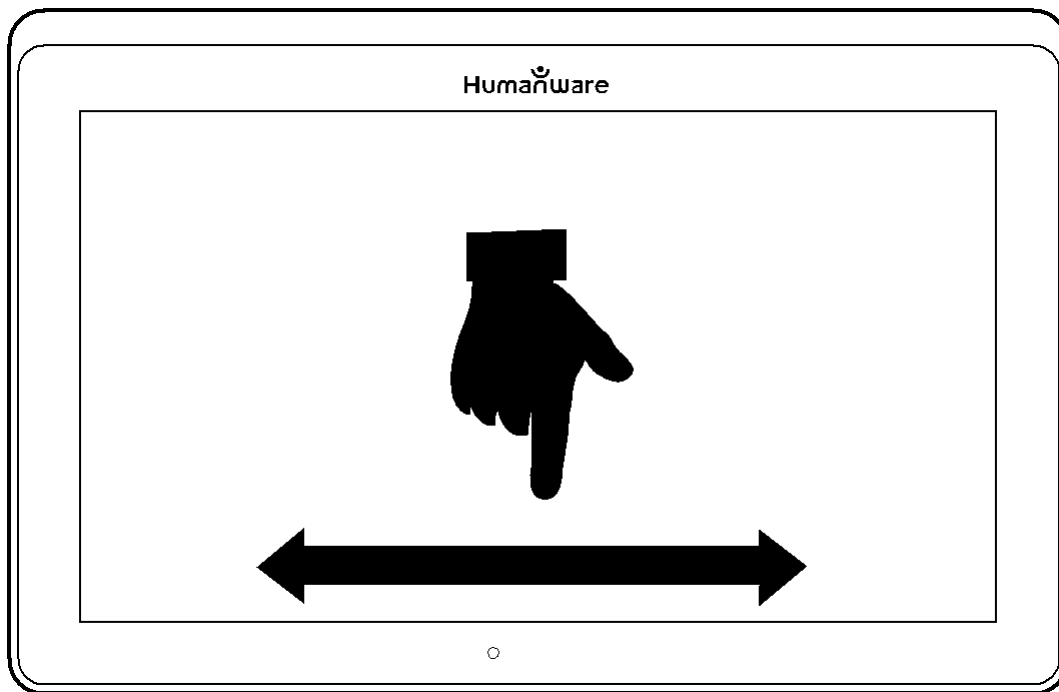

**Note:** You can also increase or decrease the speech rate permanently from the Settings. Tap the Settings button, select Speech Rate, and select a value. Tap Back twice to exit Settings.

**Note:** You will be able to change the reading speed (text scrolling speed) by swiping left or right, or from the Settings even when speech is deactivated.

- To toggle between Speech On and Off, simply double tap on the screen while reading. Alternatively, tap the Settings button, select Speech, and select Documents only or Off.
- Prodigy allows up to four different voices that can be used to read aloud text documents. To select a different voice, tap the Settings button, select Voice, and tap to toggle between the four reading voices.
- Tap Back to return to your document. Make sure that the language of the selected voice is the same as in the document you want to read.
- Tap Back to stop reading and return to camera view.

## Handwriting Tool

Prodigi features a handwriting tool useful for highlighting, drawing on or writing text on your captured images.

To open the Handwriting Tool:

- Open a saved image from the Gallery or save a captured image in the Magnifier.
- Tap the Pen and Ruler icon from the button banner. This is the Handwriting Tool button.

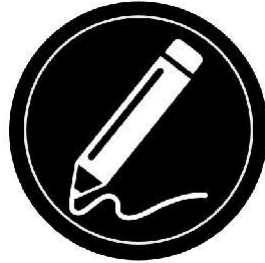

Once in the Handwriting Tool, you will notice four new buttons on the button banner.

The Tool Selection button allows you to select between the Pen, the Highlighter or the Text Tool. The icon displayed will change depending which tool is currently selected.

The Pen, Highlighter and Text tool icons are shown below.

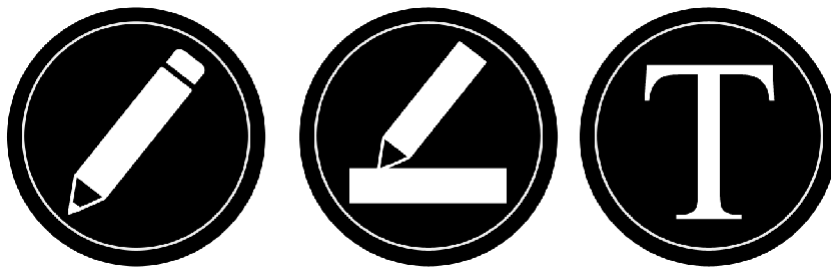

The Eraser Tool is used to erase pen/highlighter strokes and text.

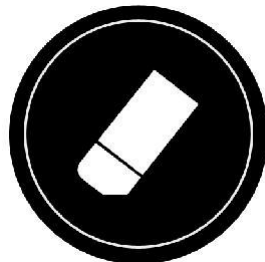

The Color Selection button opens the color menu. Tap it to choose the color of your selected tool.

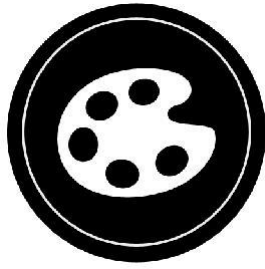

The Size Selection button opens the size menu. Tap it to choose the size of your text or the pen/highlighter strokes of your selected tool.

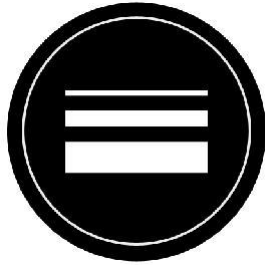

To use the pen or highlighter:

- Select either the pen or highlighter by tapping the Tool Selection button on the Button banner (second button). Drag your finger on the screen to draw strokes with the pen or highlighter.

To erase text or pen/highlighter strokes:

- Select the Eraser Tool by tapping the Eraser Tool button (third button).
- Drag your finger over what you wish to erase.
- When you are done, deselect the Eraser Tool by tapping the Eraser Tool button again.

**Note:** The Eraser Tool will only erase strokes of the selected tool type.

To write text:

- Select the Text Tool by tapping the Tool Selection button on the button banner (second button).
- Press and hold your finger on the screen where you want to write your text.
- A virtual keyboard will appear on your screen; use it to type in your text. You can also use a physical Bluetooth keyboard if you have one paired with your device.

- When you are done typing, press the Paper Plane button on the top right corner of your screen to validate your text. Alternatively, you can press **Ctrl + Enter** to validate your text if you are using a Bluetooth keyboard.

To move your text:

- Select the Text Tool by tapping the Tool Selection button on the button banner (second button).
- Tap once on your text to select it. You will see a red box appear around your text meaning it is now selected.
- Drag your text to its new position.
- Tap anywhere on the screen to deselect your text.

To resize your text:

- Select the Text Tool by tapping the Tool Selection button on the button banner (second button).
- Tap once on your text to select it. You will see a red rectangle around your text which means it is now selected.
- Change the text size by making a pinch gesture: decrease the distance between two fingers to reduce text size, and increase the distance to enlarge your text.
- Tap anywhere on the screen to deselect your text.

To Pan in an image that is being edited:

- Place two finger on the image.
- Drag your fingers up, down, right or left.
- When finish lift your fingers of the image.

Note that if the distance between the fingers varies while panning, the image will zoom in or out.

## Configuring and using the Rapid Toggle Feature

Rapid Toggle allows you to quickly access your favorite applications by swiping across the screen.

To use the Rapid Toggle feature:

- Go to Settings and tap on the Applications item.

- Select the Rapid Toggle application.
- To enable the Rapid Toggle feature, you must select at least one application. You may use Search to manually type the application you wish to add, or Select Application to select as many apps you wish from a list.
- Rapid Toggle is possible by swiping 2 fingers at the middle of the screen, starting on the left and off screen towards the right of the screen. Prodigy will detect your swipe and toggle to the next app you have selected to be part of your list.

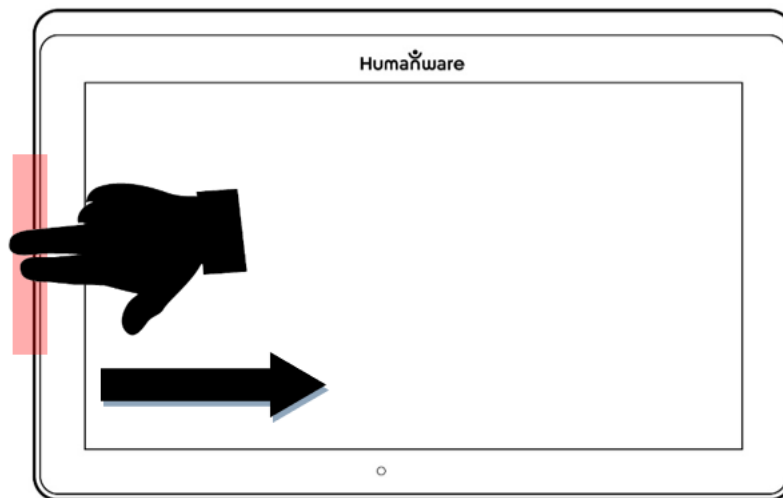

- You must swipe every time you want to toggle. Rapid Toggle will toggle to the next app using the same order in which you selected them.
- The Rapid Toggle can be used from any application.

## Activate the Blue Light Filter

Prodigi is equipped with a blue light filter that allows you to reduce the amount of blue light displayed on the screen. Blue light is known to reduce the production of melatonin, which is a sleep-inducing hormone, so filtering it is a useful way to prevent insomnia.

To activate/deactivate the Blue Light Filter on the MATT Connect:

- From the Carousel Menu, select the Settings icon:



- In the Settings menu, choose the option ‘User interface’.
- Choose the option ‘Blue Light Filter’.
- Four levels of filter will be available: low, medium, high, and max. Choose the item of your choice by tapping on it.
- The screen color is now changed according to your choice.
- When the Blue Light Filter is set to on, you can deactivate it by going back in the Blue Light Filter menu and selecting the option ‘Off’.

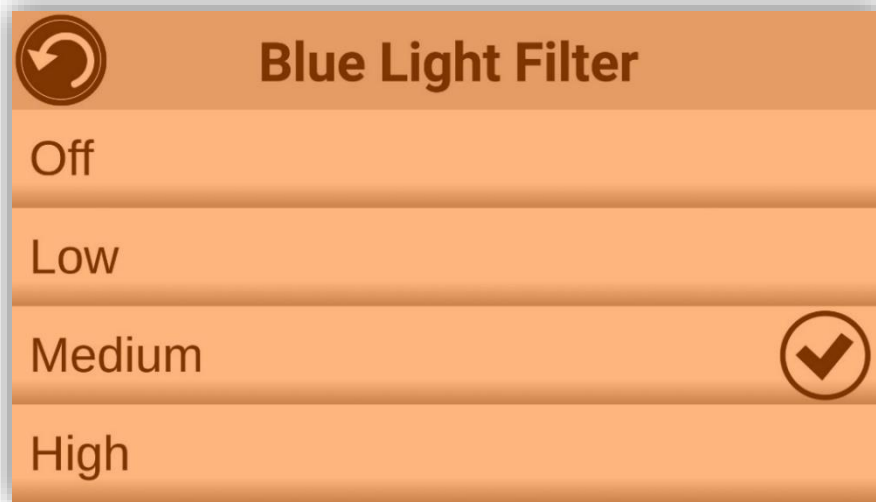

## Using the Carousel Menu

The Prodigy carousel on the MATT Connect has 10 main applications – Calculator, Dictionary, Books, Distance Camera, Notes, APH Toolbox, Magnifier, Gallery, Settings, and Help. They are presented one by one in the carousel menu:



To access the carousel menu from the Magnifier:

- Tap Back to close the Magnifier and access the carousel menu.
- Prodigy will announce “Main Carousel” followed by the currently selected application.
- The currently selected application is positioned in the center of the screen.

- Swipe left or right in the carousel menu to select an application.
- To launch a selected application, simply tap.
- To cancel and return to the carousel menu, tap Back.

**Note:** You can access the Carousel menu from anywhere in the system by double tapping with two fingers anywhere on the screen.

## The APH Toolbox



Prodigi on the MATT Connect has come preloaded with a toolbox of apps developed by APH and other vendors. Simply touch the APH icon on the carousel menu to access the apps. Once you are in the APH Toolbox you can access any of the apps listed without switching to Android. The APH toolbox also contains a link to a webpage hosted by APH. You can visit this webpage to find other apps that you may find useful.

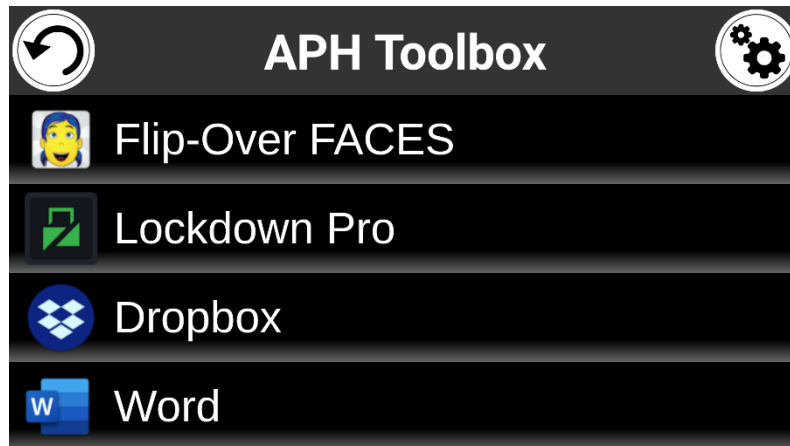

When you touch the APH carousel icon, you enter the APH Toolbox where the apps will be found. Touching an app name will start that app.

The APH Toolbox is also customizable. You can change the apps listed in the toolbox and the order in which the apps appear. To access the menus to perform these tasks, simply press the Settings button on the top right corner of the screen while in the APH Toolbox.

## Downloading Books

The Prodigy Books application allows you to download eBooks, magazines and other periodicals provided through various international libraries. Note that books can now include images and graphs when using page mode.

- To set a different Reading Mode, tap the Settings button and swipe up to select Reading Mode.



- Tap Reading Mode to toggle the value. Tap Back to exit the Settings.

To download reading material:

- Select and tap on the Books icon in the carousel menu:



- When opening Books, you must select one of the Books or Subscriptions providers from a list. To do so, select Manage libraries, then select Book providers or Magazine providers.
- Tap any library and authenticate with the username and password you have been provided with by that organization. First, enter your username and tap the blue button on the right side of the keyboard. Then, enter your password and tap the blue button again. Your login information will be saved.

**Note:** Your password will be hidden by default. Tap the Eye icon on the right of the password field to show your password in clear text. Tap again to hide your password.



- Once you have successfully authenticated, tap the Back button twice until you return to the main Books menu. Each library for which you have established a successful login will now appear on this list.
- Each library has different search fields. Some may offer you to look up either by: Title, New releases, Author, Keyword, Category, Content, ISBN, etc.
- To download a book you would like to read, tap the Download button while viewing book details. The book will be added in My Books submenu.
- To read a book you downloaded, select My Books submenu. Select the book from your list and tap to open it.
- To download a magazine or newspaper, you first need to subscribe to the periodical by going into the Periodicals submenu, select a category, tap on the periodical you would like to subscribe, a check mark will appear on the right and a popup windows will inform you that you have added the periodical to your library.
- Tap on the back button twice to go back to the Book's main menu.
- To read a magazine or newspaper you downloaded select My Subscriptions, select the magazine or newspaper you want, tap on the issue that has a big black arrow on the right of its issues date. Once the download completed, tap on the issue to start reading it.
- Press Read to start reading it as you would for any other document.
- Press Read again to pause. You will then be able to swipe left or right to navigate between the book's pages.
- You can also navigate by chapter in your downloaded book using the Table of Contents button on the button banner:

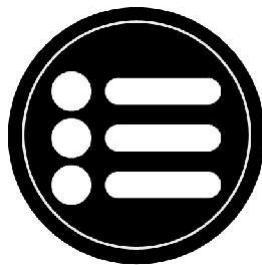

- You will see a list of the downloaded book's chapters, swipe up or down in the list, select a chapter, and press Read to start reading from that point.

- Press Back to exit and return to your list of downloaded books.
- Press Back again to return to Books' menu.

## Go to page feature

The Books application in Prodigy has a Go to Page feature that allows quick, easy navigation to any page within a book.

**NOTE:** *This function only works for books that have pagination and/or a table of contents from the publisher.*

Table of contents navigation:

- When a book is open, tap on the Navigation button and select Table of Contents. The Table of Contents will open.
- Tap on the section or chapter you wish to access to from the Table of Contents.
- Prodigy will take you at the page where the selected section or chapter begins.

Go to page navigation:

- Tap on the Books Navigation button. A menu will open.

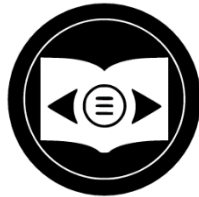

- Tap on the 'Go to page' option in the menu. A text field will appear.
- Enter the number or the name of the page you wish to access and tap the Ok button. Prodigy will access the book at the selected page.

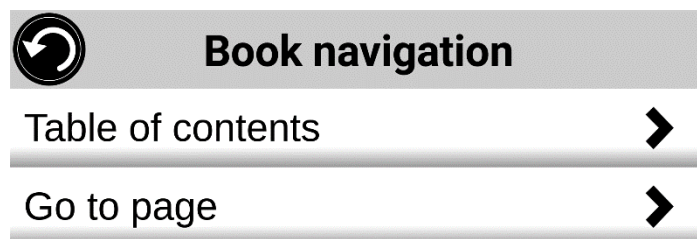

Page list navigation:

- Tap on the Books Navigation button. A menu will open.
- Tap on the option 'Pages list' in the menu.
- Select the page you wish to access from the list. Prodigy will access the book at the selected page.

## Annotate a book

It is possible to add three different types of mark-ups to downloaded books to meet a variety of personal and educational needs: 1) written notes using the touch screen, 2) highlighting, and 3) typed text notes.

Adding a written note using the touch screen:

- In the button banner, tap on the Pen icon. Options to select a pen, eraser, color palette, and line thickness will appear.



- Tap on the pen to create annotations. You can now use the touchscreen to write directly on the page using your finger or the stylus pen.
- If you wish to erase an annotation or clean up errant mark-up, tap on the eraser icon. You can erase the desired annotation by sliding your finger or the stylus over the area where it is written.
- Tap on the Return icon to exit Annotation mode.

Highlighting a text passage:

- In the button banner, tap on the Pen icon. Options to select a pen, eraser, color palette, and line thickness will appear.
- Tap on the pen to create annotations. Tap on the pen again to switch the Pen tool to a Highlighter tool. You can now use the touchscreen to highlight directly on the page using your finger or the stylus pen.



- If you wish to erase a highlighting or clean up errant mark-up, tap on the eraser icon. You can erase the desired highlighting by sliding your finger or the stylus over the area where it is written.
- Tap on the Return icon to exit Annotation mode.

Typing text notes:

- In the button banner, tap on the Pen icon. Options to select a pen, eraser, color palette, and line thickness will appear.
- Tap on the pen to create annotations. Tap on the pen twice to switch the Pen tool to a Highlighter tool, then to a Text Typing tool (“T” icon).

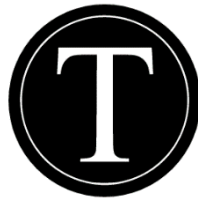

- Now tap on your document/book. A text box will appear.
- Tap inside the text box to use the onscreen keyboard.
- Type your annotation. When you are done, tap send.
- If you wish to move the text box containing your annotation, you can do so by pressing and holding on the text box, then sliding your finger to the location where you wish to place it.
- To erase the typed text from your document/book, choose the eraser icon and slide your finger or stylus over the note.

## Bookmarks

Bookmarks are a useful way to keep your location within the book and allow you to return quickly to information you have marked as important later. Once a bookmark is added to a specific location within a book, it is possible to access this bookmark at any time, to rename it, and to delete it.

Adding a bookmark:

- Tap on the bookmarks button, located at the top right corner of the screen. The bookmark menu will open. Note that if you are navigating in page mode, the bookmark icon will be visible at the left of the screen.



- In the bookmark menu, tap on the item 'Add'.
- Enter the bookmark name in the text field that will appear. Press the arrow button to confirm the bookmark name.

**Note:** *Bookmark names are limited to 40 characters.*

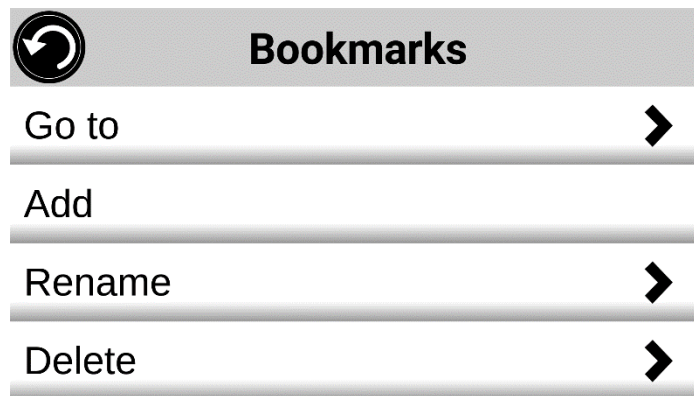

Accessing a bookmark:

- While a book is open, tap on the bookmark button. The bookmark menu will open.
- In the bookmark menu, tap on the item 'Go to'. A submenu will open listing all the bookmarks present within the book.
- Select the bookmark that you wish to access from the list. Prodigy will access the book at the location of the selected bookmark.

Renaming a bookmark:

- While a book is open, tap on the bookmarks button. The bookmark menu will open.
- In the bookmark menu, tap on the item 'Rename'. A submenu will open listing all the bookmarks present within the book.
- Select the bookmark that you wish to rename from the list.
- Enter the new bookmark name in the text field that appears. Press the arrow button to confirm the bookmark name.

**Note:** Bookmark names are limited to 40 characters.

Deleting a bookmark:

- While a book is open, tap on the bookmarks button. The bookmark menu will open.
- In the bookmark menu, tap on the item 'Delete'. A submenu will open listing all the bookmarks present within the book.
- Select the bookmark that you wish to delete from the list.
- Prodigy will prompt "Are you sure you want to delete this bookmark?". Tap Yes to confirm.
- Alternatively, scroll down to select the item 'Delete all bookmarks' to delete all the bookmarks present within the book.

## Using the Calculator

Prodigi allows you to perform calculations with the Calculator application.

To use the Calculator:

- Select and tap on the Calculator icon in the carousel menu:

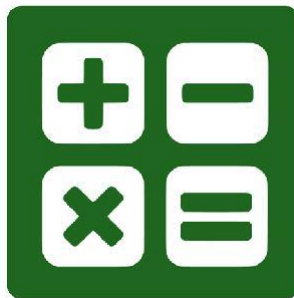

- Tap on the numbers and signs. Your calculation will appear on the top section of the screen. Tap DEL to correct it if necessary, or equal to see the answer.
- Once you have your answer, you can tap CLR to clear the top section.
- By default, the Calculator is set to standard mode. To use mathematical functions such as sin, cos, tan, etc., you will need to toggle to scientific mode. To do so, press the Settings button, and tap to set the Calculator mode setting to scientific. Press Back to return to Calculator. You will then be able to tap the two arrows on the lower center of the screen to access scientific mathematical functions.

- Tap the Back button to return to the carousel menu.

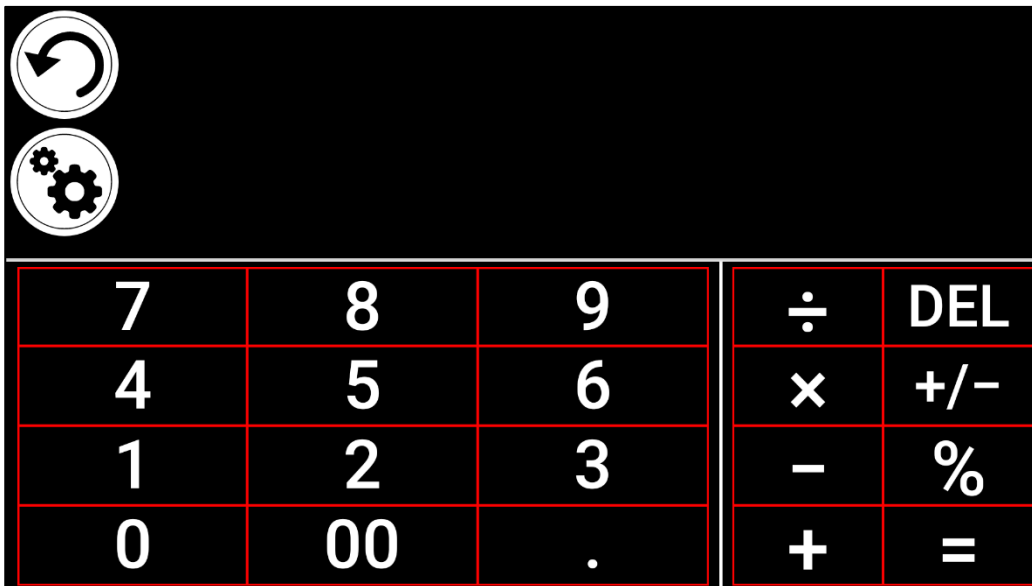

## Graphic Calculator Powered by Desmos

The integration of Desmos' graphic calculator into Prodigy means users can draw their own graphics directly on their tablet by simply entering their equation.

To switch to the graphic calculator:

- Press the Settings button in the Calculator.
- Press Mode
- Select "Graphing"
- Press back twice to return to the Calculator.

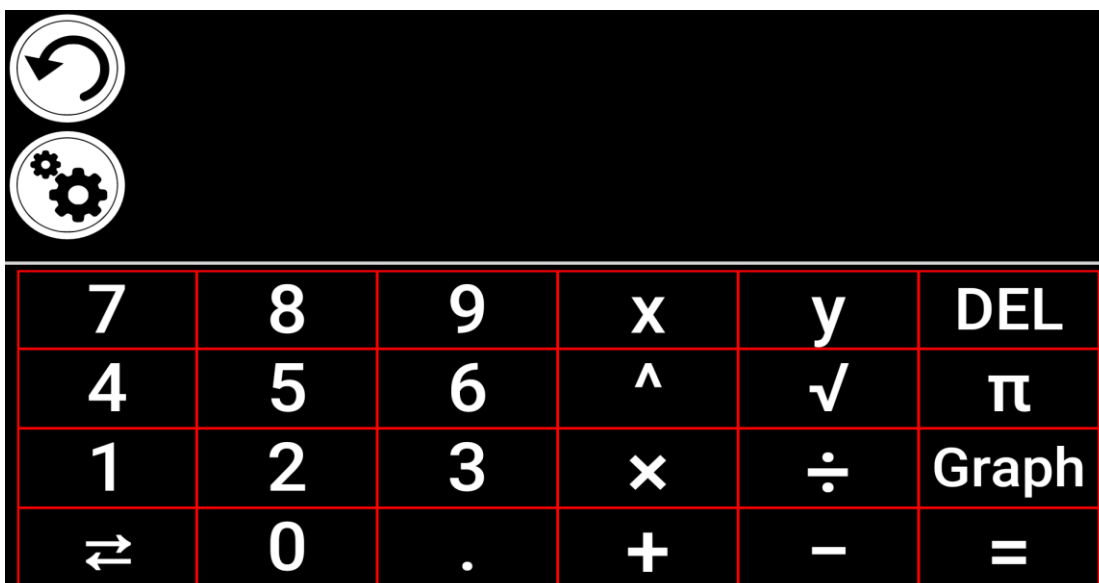

To draw a graphic, simply write a valid equation then press “Graph”.

Example:  $3x+2=y$ ,  $y=4$ ,  $0.5+x^2=y$ , etc.

Press the Plus and Minus buttons to zoom in and out of the graphic. Swipe your finger on the screen to pan the graphic.

Advanced mathematical operators are available by pressing the button with two opposing arrows in the bottom left corner of the calculator’s keypad.

When a Graph is displayed on the screen, it can be captured and saved in the Gallery under the Screenshot folder.

## Dictionary Tool



The Dictionary Tool, developed in partnership with Accessbyte and powered by Oxford Languages, is a convenient, time-saving feature that can be accessed via the Carousel menu and used as any other electronic or on-line dictionary.

### Searching for a Word

- Tap ‘Search for a word’ (or the magnifying glass icon at the top, left of the screen), then enter a word in the pop-up keyboard and tap Search.



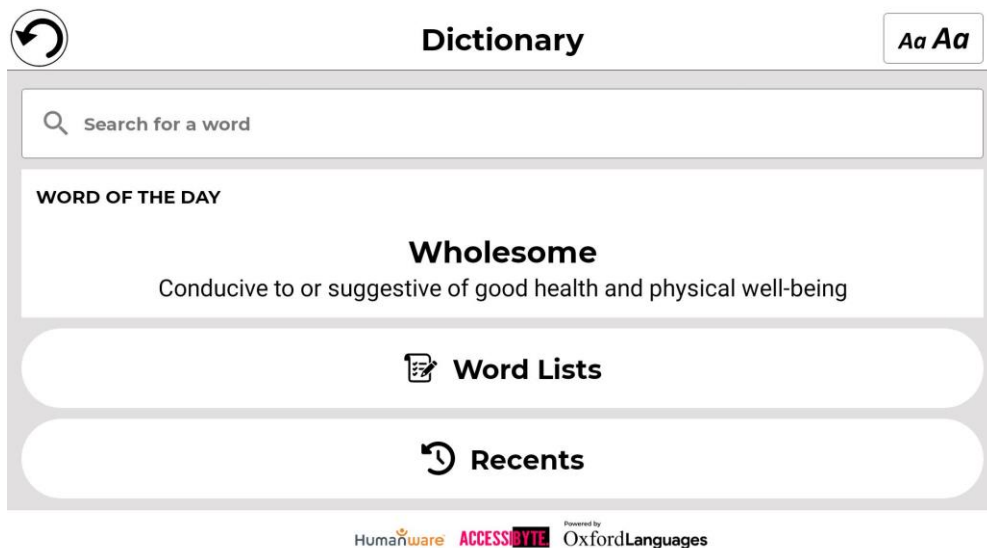

A suggestions list will appear including the word that was typed in the search field (that word appears at the top of the list), as well as other similar words. Note that the suggestions list can vary in length depending upon the number of variants found in the dictionary.

- Tap a word that appears in the suggestions list and the definition will automatically display.

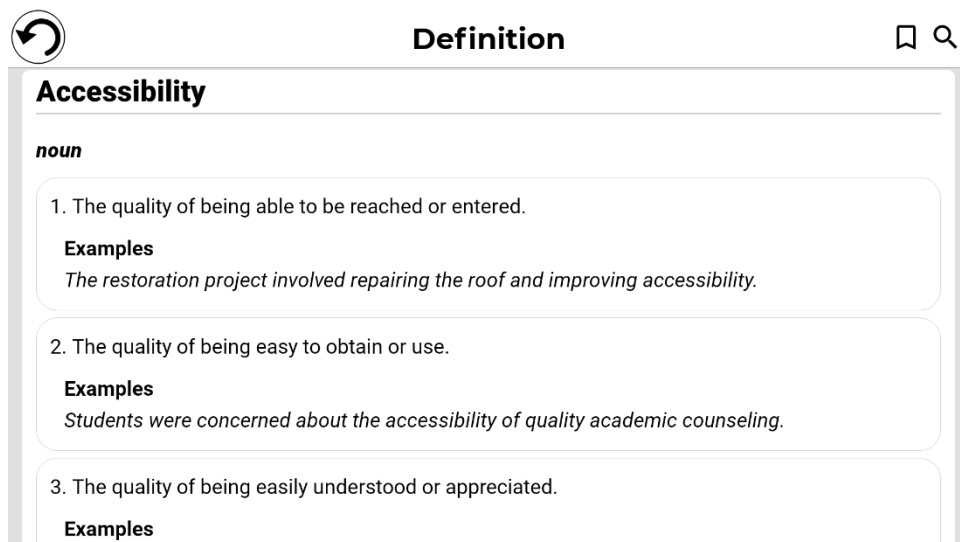

Users can save word definitions to a word list via the Bookmark icon at the top, right of the page.

- Tap the Bookmark icon.

The 'Add to which list?' pop-up box will appear.

- Tap Create New List.
- Enter the list name in the ‘Save word to list’ pop-up box.
- Tap Save.

The word will be saved to the list and can be accessed by tapping the Bookmark.

Multiple lists can be created and saved, for example: subject area specific, regularly used words, technical terms, cooking tools or nautical hardware terminology, etc.

Tapping the Magnifying glass icon (next to the Bookmark icon) will take you back to the "Search for a word" page so that you can search for another word.

### **Adjusting Font Size in the Dictionary Tool**

The main page includes a font size selector icon at the top, right of the page.

- Tap it repeatedly to cycle through three available font sizes (small, medium\*, and large). Stop at whichever size suits your needs.

The main page also features a Word of the Day. This is a random word selection and corresponding definition, that updates on a daily basis.

On the same page, the Word Lists icon appears below Word of the Day. Tapping it will bring up all word lists that have been created.

The Recents icon appears under Word Lists. Tapping it will display your recently searched words.

### **Language Selection (default US English)**

- On the Dictionary main page tap the "Search for a word" box
- Change the dictionary language by tapping the oval icon at the top, right of the screen. This will take you to the Dictionary Languages page.
- Select and tap one of the four language options.
- Tap the back arrow (top, left of the page) to return to the "Search for a word" page.

## Show / Hide Option

By default, the Dictionary icon is included in the Prodigy Carousel, however, the icon can be hidden to simplify the interface.

- Tap Settings in the Carousel. Scroll to and tap Applications.
- Tap Show (available options are Books, Calculator, Dictionary)
- Uncheck Dictionary
- Tap the Back icon three times to return to the Carousel menu (the Dictionary icon will no longer appear).
- To return the icon to the Carousel menu, follow the same process, but ensure that Dictionary is *checked*.

## Viewing Saved Documents

The Gallery contains all the documents you have saved.

- Select and tap on the Gallery icon in the carousel menu:



- Swipe left or right in the Gallery to flip through your saved documents. Note that all the screenshots taken on the device are saved in a Screenshots folder.
- The currently selected document is in the center of the screen. Prodigy will announce and indicate the first word contained in the currently selected document. If the document contains no words, Prodigy will tag it as an image. A notebook icon will indicate a multipage document:



- To open a selected document, simply tap.
- Tap somewhere on the document to see that section at your preferred zoom level.

- You can toggle between color, positive, negative, and Diamond Edge™ (if the image contains text) contrasts, and adjust the brightness in the same way as with the Magnifier (see section Magnifying for more information).
- Once you are in a zoomed level over 1X, you can move around your zoomed document by doing a Pan Gesture.
- Pan to reach other parts of the enlarged image.
- Tap or tap Back to return to the full image view.
- When in full image view, tap Back to close a document and return to the Gallery.

## The Gallery Settings Menu

The Gallery Settings Menu allows you to:

- Create categories and subcategories (folders)
- Create a new page
- Create a new document
- Append pages in a multipage document
- Reach a specific page number in a multipage document

To access the Gallery settings, simply tap the Gears icon in the top right corner of your screen while in the Gallery.

## The Action Menu

The Gallery features an “Action Menu” that includes many useful functions for your saved documents.

In the Action menu, you can:

- Renumber the first page of a multi-capture document
- Create a new category.
- Rename a document or category.
- Delete a document, category, or the content of a category.
- Move a document to a category.
- Export a document to a JPG, text or PDF file in the Android file system or an external drive.

- Move an image captured with the Distance Camera to the Gallery for Diamond Edge processing
- Delete, replace, insert, or append pages in a multipage document.

To access the Action menu, simply long press on a document or category icon in the Gallery. You will be directed to a menu listing available actions for your selected file.

### **To delete a document, a category, or the content of a category**

- Long press on the document or category you want to delete.
- Tap Delete, Delete category or Delete category content.
- Tap Yes to confirm deletion.

### **To rename a document or category**

- Long press on the document or category you wish to rename.
- Tap Rename or Rename category.
- Type in the new name of your document or category.
- Tap DONE (Enter key on keyboard).

### **To create a new Category**

- Long press on any document.
- Tap Create new category.
- Type in the name of your new category.
- Tap DONE. Categories will be sorted alphabetically in Gallery.

### **To move a document to a category**

- Long press on the document you want to move.
- Tap Move.
- Tap the category where you wish to move your image.

### **To import a JPG, text, or PDF file from an external drive to the MATT Connect**

- To make your USB key detected by the system, you need to modify the USB settings in the Android system:
  - Press and hold four or five fingers on your screen. A page displaying all the Android apps will appear.

- From the apps page, select Settings.
- In the Device list of the Settings menu, select USB.
- At the top of the screen a message will display: “USB is connected to the computer”. A toggle at the right of the screen allows you to change it to “USB is not connected to the computer”.
  - Tap on the circle at the bottom of the tablet to go back to Prodigy.
- Insert your USB key in the USB-C port at the right of the tablet. If your USB key is not compatible with a USB-C port, use the USB to USB-C connector.
- Select and tap on the Gallery icon in the Carousel menu.
- Tap on the Settings icon at the top-right of the screen, then select Import:
- Two storage options will be displayed: the Internal storage and Store N Go, corresponding to your USB key. Tap on the Store N Go option.
- Your USB key will appear. Press on its name, then press on Select to open it. All the folders and files stored on your USB key are now accessible.
- Tap on the files of your choice to import them to your Gallery. They will be automatically downloaded on your MATT Connect.

### **To export a document to a JPG, text or PDF file in the Android file system or an external drive**

- In the Gallery, press and hold on the document you wish to export.
- Tap Export.
- Select in which file type you wish to export your document. It is possible to modify some JPG and PDF settings by pressing and holding either the PDF or JPG option (advanced users only).
- Select the Internal storage to export to a specific folder on the device. You can also select the USB device option if a USB key is placed in the USB port of the tablet to export it to the USB thumb drive.

### **Move an image captured with the Distance Camera to the Gallery**

- In the Distance category, hold your finger on the image you wish to move.

- Tap Move to Gallery.
- The image will be treated to find text and display Diamond Edge if text was found. The file will be renamed to first found word in document, if text is found.
- The file can be then moved into a Category if required.

## To delete, replace, insert, or append a page in a multipage document

- Open the multipage document you wish to modify.
- To delete a page, long press on the page you wish to delete and tap Yes to confirm deletion.
- To replace a page, long press on the page you wish to replace. Tap replace, tap yes and capture a new page.
- To insert a page, long press on the page where you want to insert a new page. Tap insert and capture a new page.
- To append one or several pages, long press on any page in a multipage document and tap append. Capture your document. The page(s) will be added at the end of the multipage document.

## Add a function graph in a document

While editing a document, you have the option to add a function graph.

- Select and tap on the Gallery icon in the carousel menu:



- Open a document.



- Perform a long press on an item inside the document.
- A settings submenu will appear. Select the option 'insert'.
- The insert options will appear on the screen. Select the option 'New Function Graph'.
- Prodigy will open the calculator app in the graph mode. Enter a formula and selects the 'graph' button.

- Prodigy will open the graph view with the user function plotted. Tap on the 'save' button.



- Prodigy will return to the document with the graph image inserted in the select position.

Alternatively, if you wish to append a function at the end of a document:

- Select and tap on the Gallery icon in the carousel menu:



- Open a document.



- Tap on the 'more options' button on the top right corner of the screen. A menu will appear.
- Selects the option 'Append'. The append menu will appear on the screen.
- Select the option 'New Function Graph'.
- Prodigy will open the calculator app in the graph mode. Enter a formula and selects the 'graph' button.
- Prodigy will open the graph view with the user function plotted. Tap on the 'save' button.



The graph will appear at the end of the document.



## Navigating Out of Advanced Interface

From the Settings Menu, select User Interface; within this submenu, select Interface: Advanced. This will display the different interface options for selection. Once you have chosen the desired interface, engaging the Back button will confirm the selection.

## Using the Distance Camera

MATT Connect features a distance camera that can be extremely useful when you need a better view of something at a distance, such as a presentation or the teacher's slides during a lecture. Your distance camera connects wirelessly, has a battery duration of 4 hours, and can be set up to 30 feet (10 meters) from MATT Connect. The camera comes already paired with your tablet out of the box.

- To use the Distance Camera, first align your camera with the object you wish to view.
- Turn camera on.

**Insert your camera into the camera stick slots, located on either side of the folding stand's frame.**

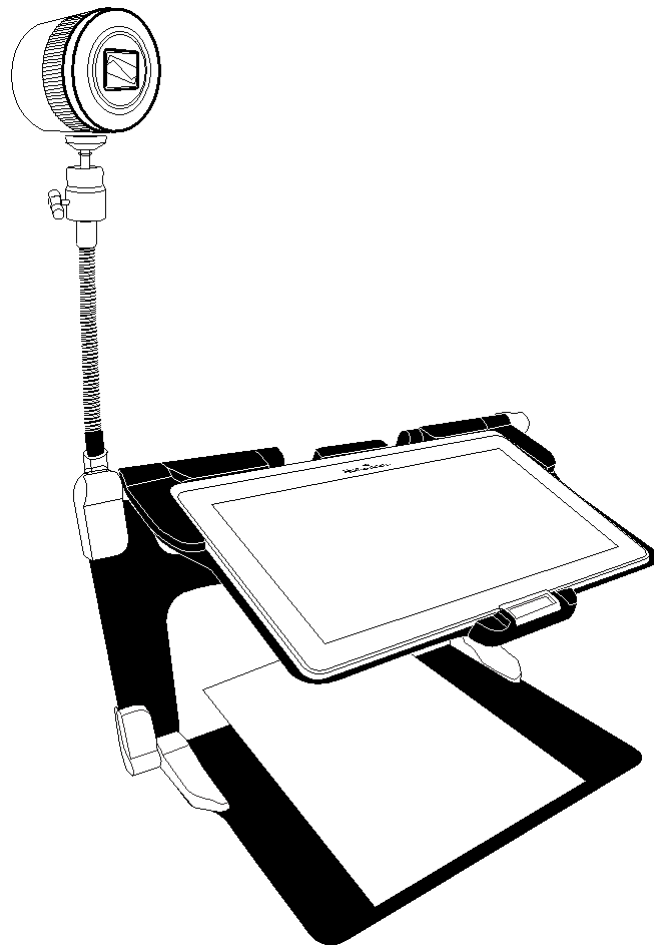

- Enter the Carousel menu by tapping the Back button in the magnifier mode.
- Select the Distance Camera icon, then tap.



- You are now in your camera's live view. To take a picture, Tap the Capture button. Alternatively, you can take a picture by holding down the Shutter button located next to the Zoom lever on the left side of your camera.
- You should hear a camera shutter sound and briefly see the picture you just took, then return to the camera's live view.

- You can zoom in or out by tapping or tapping and holding the Zoom In and Out buttons. Alternatively, you can use the Zoom lever located next to the capture button on the left side of your camera.
- Tap Back to return to the carousel menu.

## Toggle between Distance Camera and Magnifier

During a lecture, you may want to switch quickly between the distance camera and the magnifier to note down what the teacher is writing on the board.

To switch between the distance camera and the magnifier view seamlessly, simply swipe your finger on the screen from left to right. Swipe again from left to right to return to your previous view.

## Using Distance Camera and Magnifier Simultaneously

It is possible to use the distance camera and magnifier simultaneously. To do so, simply touch the arrow on the left side of the screen and your screen will split into two with the distance camera in the top section and the magnifier view in the bottom section.

You will notice there is a red or blue selection box around either the top or bottom view; this indicates which section is selected. To go to full screen mode in one of the views, select a view by touching it then touch again to go full screen.

To take a capture without leaving split screen mode, select the view you wish to take a capture from by touching it, then touch and hold your finger in the view to take the capture.

## Writing Notes



The Notes app in Prodigy provides you with a quick and simple way to take notes on your MATT Connect.

To write a note:

- Tap the Notes application in the main carousel.
- Press the + button in the top right corner of the screen to create a new note or a category.
- Click the newly created note to open the Note editor.

The Note editor works identically to handwriting tool, covered earlier in this user guide. See the Handwriting tool section of the Advanced Interface on page 32 for more details.

## Viewing Distance Camera Images

Pictures taken with the Distance Camera can be viewed in the Gallery similarly to the pictures taken with the Magnifier.

To view pictures taken with the Distance Camera:

- Select and tap on the Gallery icon in the carousel menu.



- Swipe right until you have selected the Distance Camera picture icon (a spyglass in front of a folder), then tap once.
- If Speech Mode is On, the currently selected document is in the center of the screen. Prodigy will announce the title of the capture and indicate the date the picture was taken.
- Swipe left or right to scroll through the available pictures.



- To open a selected document, simply tap.

## Reading with the Distance Camera

To read a picture taken with the Distance Camera, you will need to transfer the picture from the Distance category to the root of the Gallery.

- In the Distance category of your Gallery (a folder with a spyglass), hold your finger on the image you wish to move.
- Tap Move to Gallery.
- Your image should now be in the root of your Gallery where it can be read just like any other document.

## Removing Distance Camera from Stick

Your Distance Camera comes already attached to the camera stick.

If you wish to remove it from the stick, do the following:

- Make sure your camera is turned off.
- With one hand, firmly hold the camera.
- With your other hand, locate the thumbscrew located underneath the camera, and begin loosening it until the camera is detached from the stick.

**Warning:** The camera is very fragile, so make sure you are holding it properly before removing it from the stick.

## Viewing Text Files in Prodigy

Prodigy allows you to paste text files into the gallery and then open them using the Prodigy interface.

**To paste a text file in Prodigy:**

- Copy to your tablet's clipboard the text you wish to add to Prodigy. This can be done outside Prodigy in Android applications that allow you to copy text (e.g. your internet browser, Dropbox or your emails.).
- Tap Back to open the Carousel menu.
- Select and tap on the Gallery icon in the carousel menu.



- Swipe until the Text icon is selected, then Tap to open the text section of the Gallery.



- Swipe until the Paste icon is selected, then Tap to paste the text you copied earlier.



- Your text will appear in Diamond Edge in column reading mode (original layout and images are not available).
- Tap back to return to the Text section of the Gallery.
- The text you pasted will now be saved in the Text section of the Gallery and will be named after the first word of your text.

## Exam Mode

The Exam mode is used to block certain functions and applications from the MATT Connect for a certain amount of time. While the Exam Mode is activated, the blocked functions and applications can only be accessible by entering a predetermined PIN number or by waiting for the time to run out.

To activate the Exam Mode on the MATT Connect:

- From the Carousel menu, select the Settings icon:



- In the Settings menu, select the Exam Mode item. A submenu will be displayed on the screen.
- In the Exam Mode submenu, you can adjust the parameters by tapping on them and modifying their value. The adjustable parameters are the following:
  - Start Time.
  - Duration: Select a value between 30 minutes and 8 hours.
  - Exit to Android: Tap to enable the access to the Android application while the Exam Mode is on. Tap again to disable it.
  - Capture & Gallery: Tap to enable the access to the Gallery and the use of captures while the Exam Mode is on. Tap again to disable them.
  - Calculator: Tap to enable the access to the Calculator while the Exam Mode is on. Tap again to disable it.
- Once you have adjusted all the parameters, tap the Exam Mode: off item on your menu to toggle the Exam Mode to on.
- Tap the Back icon at the top left of your screen.
- You will be prompted to enter a PIN code to deactivate the Exam Mode.
- The Exam Mode is now ready for use.

If you wish to change the parameters of the Exam Mode while it is activated, or to deactivate it, follow these steps:

- Access the general settings by tapping the Settings icon in the Carousel menu.
- In the Settings menu, select the Exam Mode item.
- You will be prompted to enter the PIN number you created when activating the Exam Mode.
- You now have access to the Exam Mode submenu, where you can change the parameters or deactivate the Exam Mode.

## OCR Language Selection

Prodiqi allows the use of Optical Character Recognition (OCR) through various languages while using the Magnifier or the Camera.

To enable/disable the OCR:

- Tap on the Settings icon in the button banner from the Magnifier Application.



- Scroll and tap the item 'OCR: Disabled' in the Settings menu to enable the feature. If OCR is enabled, tap the item to disable it.

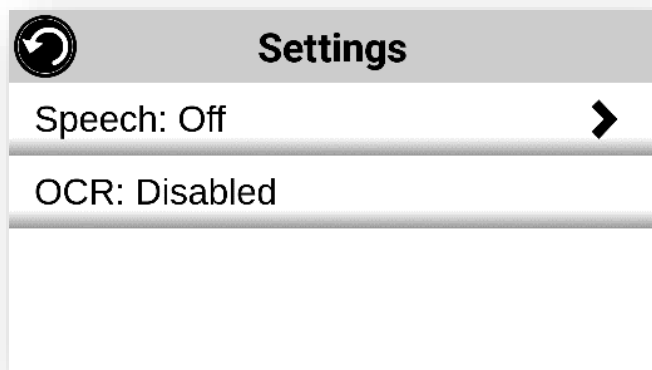

- Prodiqi will automatically display a new item in the Settings menu: 'OCR languages: Installed voices'.

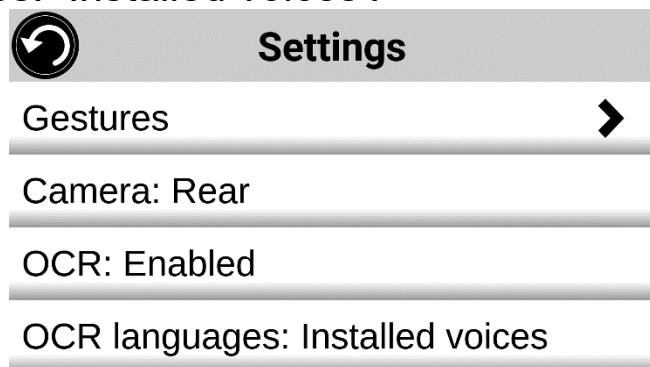

- Tap on this new item to change the Language feature to 'Custom'.
- The item 'Choose OCR Languages' will appear. Tap to open it. A list of the available languages will appear.



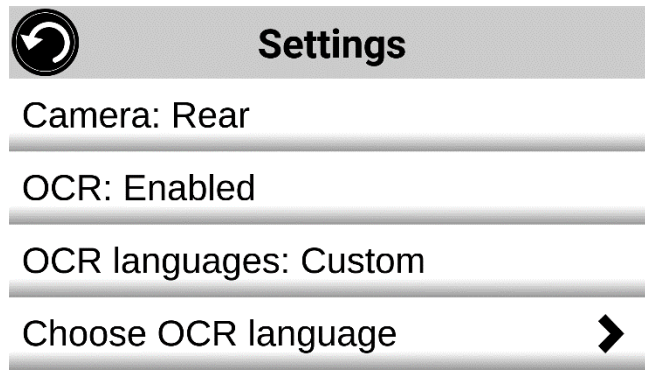

- Choose the language of your choice from the list.
- Press the Back button until you reach the Magnifier Application.

## Chapter 4: Choosing Your Contrast

Prodigi allows you to view documents, pictures, and objects in three types of contrast: **color**, **positive** or **negative**. For documents containing text, a fourth type of contrast can be used: **Diamond Edge™**. Positive, negative, and Diamond Edge contrasts are enhanced; they are meant to enhance the original color of a document or object to facilitate your visual experience.

Toggle between the different contrasts by swiping on the right edge of the touchscreen while magnifying or viewing an image or document:

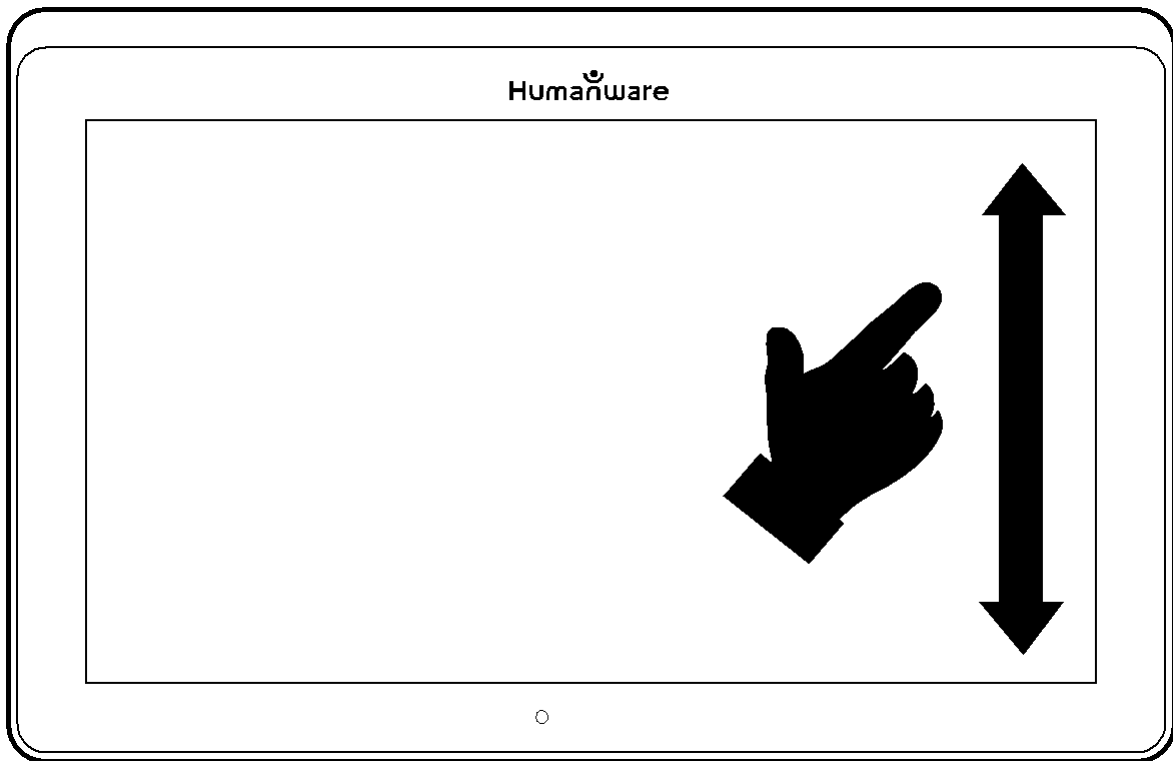

Alternatively, tap the Settings button while magnifying, viewing an image or reading, select Contrast, and swipe to choose a contrast. Tap Back twice to return to your document or object.

**Color** contrast is useful if you want to view documents, objects, and photographs in their original color.

- Your text will appear in Diamond Edge in column reading mode (original layout and images are not available).
- Tap back to return to the Text section of the Gallery.
- The text you pasted will now be saved in the Text section of the Gallery and will be named after the first word of your text.

**Positive** contrast shows text and images in two colors according to your selected color combination, the default combination being Black on White. This is a practical way to view text in the best color combination for your vision.

**Negative** contrast shows text and images in reversed contrast as compared to your selected color combination. For example, if your combination is Black on White, negative contrast will show text and images in White on Black. This is useful if you wish to reverse the contrast of a text that contains different contrasts.

**Diamond Edge** contrast combines the best of both worlds; it shows Diamond Edge Text™ in your selected color combination and images in their original color. This allows you to magnify text indefinitely without compromising its quality in the best color combination for your vision, while viewing images in their original color on the same page.

## Chapter 5: Changing Your Settings

Prodigi's settings menu is contextual; different settings will be displayed depending on what you are doing or where you are in the system.

To access the settings, tap the Settings button. Swipe down to see the battery level, and swipe up to select an item. The currently selected item is announced and highlighted by a frame. Scroll up or down to move the frame and select an item. The items will be read one at a time (by default). Tap to toggle the value or swipe when in a list of values. Tap Back (top left corner) to return to what you were doing.

**Note:** Your navigation mode will be different if your Speech setting is set to "Off" or "Documents only." There will no longer be a frame, and each menu item will have a shadow below it. In this navigation mode, you can simply touch an item to select it instead of highlighting it with the frame.

Here is a list of Prodigi's contextual settings (the values marked with a star (\*) are default settings):

- **Brightness:** 0 to 100% (50%\*)
- **Contrast:** Diamond Edge (if captured image contains text), Color\*, Positive, Negative
- **Colors** (Select from 20 color pairs): Black on white\*, White on black, Black on gray, Gray on black, Black on yellow, Yellow on black, Black on orange, Orange on black, Black on cyan, Cyan on black, Black on purple, Purple on black, Black on green, Green on black, Blue on yellow, Yellow on blue, White on blue, Blue on white, Beige on black, Black on beige.

- **Mode** (Standard mode only): Live\*, Multi-Capture
- **Autofocus** (Live mode only): Locked, Unlocked\*
- **Angle Correction:** Enabled\*, Disabled
- **Speech:** On, Documents only, Off\*
- **Voice:** Voice 1\*, Voice 2, Voice 3, Voice 4 (4 Voices maximum)
- **Speech Rate:** Very slow, Slow, Normal\*, Fast, Very fast
- **Reading Mode:** Page, Column\*, Line
- **Reading Speed:** Very slow, Slow, Normal\*, Fast, Very fast
- **Diamond Edge:** Always\*, On Request
- **Font Type:** Regular, Bold\*
- **Preferred Zoom:** 2x to 35x (4x\*)
- **Font Size:** Minimum, Small, Medium, Standard\*, Large, Very large, Extra large, Maximum
- **Highlight** (Column and Line modes only. Highlight on spoken words): Display\*, Hide.
- **Delete Gallery content** (in Gallery): Permanently delete all files in Gallery. Press the Settings button in the Gallery to reach this setting.
- **Logout** (in Books app): Log out of Bookshare. Press the Settings button in Books to reach this setting.
- **Delete library content** (in Books app): Permanently delete all downloaded books in Books. Press the Settings button in Books to reach this setting.
- **Wi-Fi Setup** (in Books app): Press the Settings button to reach this setting.
  - **Wi-Fi:** Turn Wi-Fi On or Off.
  - **Wi-Fi Networks:** List of available networks. When connected, shows network you are connected to.  
Note that proxy network connections must be set-up using Android settings.  
A more advanced option is also available when selecting a network:
    - **Advanced options/IP Settings:** Displays the host configuration protocol for the selected network.
  - **Saved Networks:** Saved networks configurations. To forget a network configuration, tap network, tap Forget, and tap Yes.

- **Mode** (in Calculator app, press the Settings button to reach this setting): Standard\*, Scientific, Graphing.
- **Grid** (in Calculator app, press the Settings button to reach this setting): Locator color\*, Red, Orange, Yellow, Purple, Cyan, Green, Blue
- **Usage Data:** On\*, Off, Details about metrics; you can opt out at any time.
- **Gestures** (while magnifying, viewing an image, or reading a document, allows you to enable/disable gestures. They are checked by default):
  - **Swipe on left edge / Mode:** Toggle between Live and Multi-Capture modes.
  - **Swipe on right edge / Contrast:** Toggle between Color, Positive, Negative, and Diamond Edge contrasts (The last selection will be saved in Prodigy's memory).
  - **Pinch and zoom:** Adjust the zoom level by decreasing or increasing the distance between two fingers.
  - **Double tap:** Access the carousel menu or toggle between Speech On and Off while reading by tapping twice quickly with one finger.
  - **Tap / Zoom:** Press your finger down quickly on the touchscreen (tap) to zoom at your preferred zoom level.
  - **Two finger press and hold:** To read aloud the button banner, press on an item with two fingers and hold when Speech is set to On.

You can access other general settings from the carousel menu by tapping the Settings icon:



You will see five main menus and one item: User Interface, Audio, System, Applications, Exit to Android, and About. Scroll up or down in the Settings to select a menu or item. Prodigy will announce “submenu” if a selected menu contains submenus and display an arrow on the right edge of the screen. To open a menu, submenu, or an item, simply select it and tap. Once you have reached the setting you want to modify, tap or swipe up in a list of values. Tap Back to return to a previous screen. Tap and hold the back button to exit the Settings from anywhere in the Settings menu.

Here is a list of Prodigy’s general settings (the values marked with a star (\*) are default settings):

### **User interface:**

- **Interface:** Advanced\*, Standard, Basic
- **System Language:** Language 1\*, Language 2, Other (will connect to the Internet to find downloadable language packs)
- **Colors** (See color pairs above in contextual settings)
- **Locator color:** Red\*, Orange, Yellow, Purple, Cyan, Green, Blue
- **Screen Brightness** (Change the screen’s brightness level): 1 to 100% (60%\*)
- **Button Banner:** Auto\*, Hidden, Always
- **Tablet Vibrations:** On\*, Off

### **Audio:**

- **Speech:** On\*, Documents only, Off
  - See section “[SpeechOn](#) to use Speech On mode
- **Speech Rate:** Very slow, Slow, Normal\*, Fast, Very fast
- **Sounds:** On\*, Off
- **Tablet Volume:** 0 to 15 (9\*)
- **OCR Sound:** On, Off\*

### **System:**

- **Wi-Fi Setup:**
  - Wi-Fi: Turn Wi-Fi On or Off.
  - Wi-Fi Networks: List of available networks. When connected, shows network you are connected to.

- **Saved Networks:** Saved networks configurations. To forget a network configuration, tap network, tap Forget, and tap Yes.
- **Bluetooth Setup:**
  - **Bluetooth:** Turn Bluetooth on or off. When turned on, your MATT Connect will attempt to discover other Bluetooth devices and be discoverable by other devices.
  - **Paired Devices:** Devices currently connected to the MATT Connect.
    - **Forget device:** Unpairs the device. The device will remain discoverable in the Devices submenu.
    - **Rename device:** Choose another name for the device.
    - **Reset name:** Reverts to the device's default name.
  - **Devices:** Nearby Bluetooth devices discovered by Prodigy.
- **Software Update** (see Chapter 10)
- **Tablet Auto Shutoff:** 3 min\*, 5 min, 10 min
- **Restore to Factory Defaults**

### Applications:

- **Books:** Checked\*, Unchecked
- **Calculator:** Checked\*, Unchecked

### Exit to Android:

Exits Prodigy. You can return to Prodigy by pressing the Home button and tapping the Prodigy icon.

### About:

- **Software** (Version)
- **Voices** (Version)
- **OCR** (Version)
- **Books** (Version)
- **Calculator** (Version)
- **Distance** (Version)
- **Prodigy Updater** (Version)
- **Serial Number**
- **Model**

- **Android** (Version)
- **Android** (Build)
- **Base** (Version)
- **Weather** (powered by)
- **Usage Data**

### **Speech On:**

When Speech is set to ON, the navigation will be significantly different. Prodigy will read systematically all items visible on the screen for a fully assisted guidance.

### **Within menus:**

The Speech feature will read the number of items included in the menu and/or submenu selected and subsequently read the first item selected on the screen. If that item leads to another submenu, it will also read “submenu”.

For example: Settings Menu > 7 items > User Interface > Submenu

You can not directly touch a menu item to select it. You must swipe up or down to isolate the menu item you wish to select within the colored frame.

A 2-finger long press anywhere on the screen within a menu will isolate and highlight the “Back” navigation button. Once “Back” is highlighted, simply tap once anywhere on the screen and you will be brought back to the previous screen.

## **Chapter 6: Bluetooth External Keyboard**

### **Connecting a Bluetooth Keyboard**

To connect your Bluetooth keyboard to your MATT Connect:

- Make sure your Bluetooth keyboard is turned on.
- Access the general settings by tapping the Settings icon in the Carousel menu.
- Select and enter the System submenu.



- Select and enter Bluetooth Setup.
- Bluetooth will be off by default. Turn it on by tapping the Bluetooth menu item. After a few seconds, additional menu items will appear and your tablet will become discoverable by other devices.
- Select and enter the Devices submenu.
- Select your Bluetooth keyboard and tap the screen.
- Tap Connect.
- Your MATT Connect will display a PIN number. Type this number on your Bluetooth keyboard then press Enter.
- Your Bluetooth keyboard is now paired with your MATT Connect and ready for use.

## Chapter 7: APH Code Jumper®

### Connecting the MATT Connect to an APH Code Jumper®

To connect an APH Code Jumper® device to your MATT Connect:

- Make sure the Code Jumper® is turned on before establishing the connection.
- Access Prodigy settings by tapping the Settings icon in the main Carousel menu.
- Select and enter the System submenu.
- Select and enter Bluetooth Setup.
- Bluetooth will be off by default. Turn it on by tapping the Bluetooth menu item. After a few seconds, additional menu items will appear and your device will become discoverable by other devices.
- Select and enter the Devices submenu.
- Select your APH Code Jumper® device.
- Tap Connect.
- Your Code Jumper® is now paired with your MATT Connect and ready for use.

# Chapter 8: Accessing Android

Prodigi allows you to access Android applications while operating in the Advanced Interface. Please note that HumanWare provides limited support for Android and Android applications.

Android is accessible from the Settings in the carousel menu. Tap the Settings icon and swipe down to select Exit to Android.

You may also access Android by performing a four –or five– finger press and hold within the Prodigi software.

You can prevent Access to Android by pressing the capture and the back buttons simultaneously for 10 seconds and selecting yes to Disable Exit to Android option in the shown menu.

## Create a New User Profile

The MATT Connect device allows multiple user profiles to be created.

To add a new User Profile:

- Press and hold four or five fingers on your screen. A page displaying all the Android apps will appear.
- From the apps page, select Settings.
- In Settings, select the Users item.
- Select the Add user or profile item.
- Select the option User – Users have their own apps and content and tap on Ok.
- Press on the Set-up user now option that will appear on the screen.
- Follow the Android instructions to complete the user profile.

# Chapter 9: Help Menu

The rightmost item of the carousel menu is the Help Menu, where you will find many helpful videos showing you how to use your MATT Connect. The Help Menu is represented by the question mark icon below:



Upon entering the help menu, you will have the following options:

**YouTube tutorials:** Here you have access to webinars and many useful tutorials on how to use your MATT Connect tablet. Make sure to check it out occasionally to see if there's anything new.

## Chapter 10: Recharging Your MATT Connect

### Maximizing operating efficiency:

- In a working situation where you need the tablet intermittently, you can enter Standby mode when you are not using the tablet by pressing Power. The screen will power off.
- Wake tablet by pressing the Power button.
- If you will not be using the tablet for the next few days, it is recommended that you power it off by pressing and holding the Power button and selecting Power off.

### Recharging the battery:

Tap the Settings button to enter the Settings menu and to display the tablet's battery charge level. Swiping upwards in the Settings menu from the first item will announce the charge level (if Speech is set to On in the Settings).

**IMPORTANT:** Always use the charging block and cable included with your Connect 12 tablet. Other charging equipment may not charge or work properly and can cause harm to your tablet.

**IMPORTANT:** The tablet becomes warm during recharging. Do not recharge the tablet near a heat source.

**IMPORTANT:** Do not close your folding stand while recharging. Doing so could damage your cable or the tablet.

**To recharge the battery:**

- Only use power adapter and cable supplied with MATT-Connect.
- Connect the USB to USB-C cable to the USB-C port and plug it to an outlet using the power supply.
- A full charge requires 4 hours.

**Battery safety precautions:**

- Do not disassemble or modify the battery.
- There is a risk of overheating, fire or explosion if the battery is put in a fire, heated, subjected to impact, put in contact with water, or if its terminals are shorted.

## Chapter 11: Recharging Your Distance Camera

Your camera has a battery life of 4 hours and will eventually need to be recharged.

**Note:** Help of a sighted person may be required to charge your camera.

**To charge your camera:**

- Carefully plug in the micro-USB connector into the slot located under the cap.
- Carefully connect the USB connector using the Tablet's charging block.
- The charge indicator will be orange when your camera is charging and turn green once the battery is fully charged.

# Chapter 12: Software Update

## Setting Up Your Wi-Fi

Before initiating a software update, the Wi-Fi network needs to be configured.

- Tap the Settings icon from the carousel menu.
- Swipe to select System and tap.
- Tap to open Wi-Fi Setup.
- Select Wi-Fi Networks and select the network you wish to connect to.
- Tap Connect. A keyboard will appear on the screen. Enter your password and tap on the blue button. Then, tap on Connect.

## Automatic Update

When Wi-Fi is configured, Prodigy will automatically check every week for updates.

If there is an update available, Prodigy will notify you and ask you if you wish to update your tablet. When this occurs:

- Tap Install to install the latest update. Prodigy will show the download progress.
- A new window will appear telling you that your software is now up to date. Tap OK to go back to Prodigy.

## Manual Update

At times, you may want to manually update Prodigy on your MATT Connect tablet.

- Access the settings from the main menu, then select System.
- To initiate a software update, select Software Update and tap.
- Prodigy will verify if your software is up to date or if an update is available.
- If an update is available and you wish to install it, tap Install. If you wish to cancel, tap Cancel.

- If you chose to install the update, Prodigy will download the update and show the download progress.
- A new window will appear indicating that your software is up to date. Tap OK to go back to Prodigy.

## Release Notes

To view the Prodigy software release notes:

- Access the settings from the main menu, then select System.
- Select Software update.
- Select Release notes, if available.

# Chapter 13: Troubleshooting

**If the screen is blank:**

- Zoom out of the image for minimum magnification.
- The tablet could be powered off or in Standby Mode. Tap Power to power it on or to exit Standby Mode.

**If colors are difficult to detect:**

- Check if you have sufficient ambient light.
- Choose a different contrast or color combination in the Settings.
- Adjust the brightness level in the Settings.

**If there is a lot of glare:**

- Tilt object in a different direction to reduce glare.
- Reduce the brightness level in the Settings.
- Reduce external lighting effects.
- If your captured image is too bright or uneven, turn off the light on the button banner and capture a new image.

**If the image/text is out of focus or blurry:**

- Use the Zoom In-Out buttons to zoom in and then out of the image to trigger the camera's focus. If needed, capture a new image of your document.

- Make sure you hold the camera still while capturing an image.
- Make sure your tablet is powered off, and wipe the LED lights and camera surface on the back side with a cleaning tissue.

**If the audio reading does not make sense:**

- Make sure the voice setting is the same as your document's language. Change it in the Settings if necessary.

**If the tablet is not responding:**

- Make sure the battery is not empty. Recharge it if necessary.

**Other problems:**

- Restore factory defaults in the Settings.
- Contact your dealer or technical support.

**Reset the Android platform system completely**

**WARNING: This will cause you to lose your settings and personal data. IMPORTANT:** It is highly recommended that you remove any saved email service accounts from your tablet prior to resetting the settings, as you will not be able to do so after the system reset. Additional fees may apply if you need to return your tablet to HumanWare to remove the saved email accounts.

**To remove a saved email service account:**

- Open the Android Settings and go to Passwords & accounts
- Tap on the account(s) to be removed.
- Tap Remove account, then confirm you wish to remove the account.

**To completely reset the Android platform system:**

- Open the Android Settings and go to System
- Tap Reset options, then Erase all data (factory reset)
- Confirm you wish to Erase all data

**If all else fails, please contact your dealer or technical support.**



AMERICAN  
PRINTING  
HOUSE

1839 Frankfort Avenue, Louisville, Kentucky 40206

502-895-2405 • 800-223-1839

[www.aph.org](http://www.aph.org) • [info@aph.org](mailto:info@aph.org)

## Customer support

For customer support, please contact the HumanWare office nearest you or view our website at:

[www.humanware.com](http://www.humanware.com)

North America: 1 (800) 722-3393  
[support@humanware.com](mailto:support@humanware.com)

Europe: (0044) 1993 415 800  
[eu.support@humanware.com](mailto:eu.support@humanware.com)

Australia / Asia: (02) 9686 2600  
[au.sales@humanware.com](mailto:au.sales@humanware.com)

**Humanware**<sup>™</sup>  
see things. differently.

ACCD-0311  
REV 07